





LED PROFILE PEN8 I 4050 ANOD.



	<ul style="list-style-type: none">• decorative and lighting profile, eg. for glass cabinets• possibility of mounting between the walls of a cabinet	 EU industrial designs  CE  Made in Poland	 Buy product
---	--	---	--



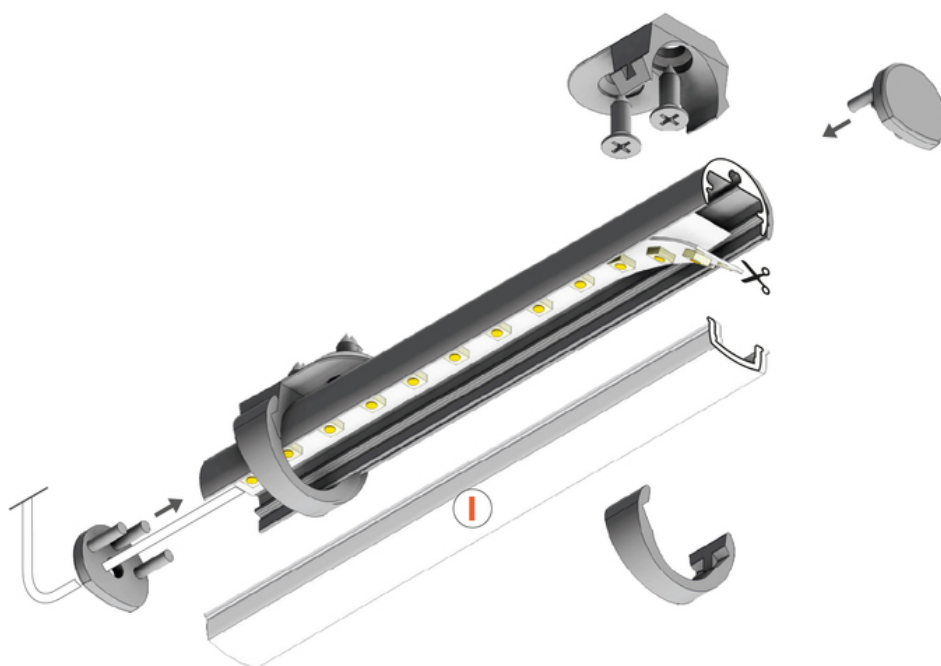
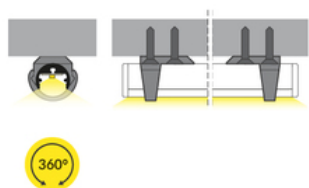
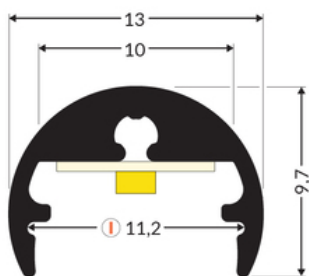

Basic Informations

EAN: 5901597251262
Index: 86540020
Material: aluminium
Color: anodized
Length [mm]: 4050
Weight [kg]: 0.446
Country of origin: PL

Measurement unit: qty
Product packaging dimensions [mm]: 4050 x 13 x 9,7
Bulk packing [qty]: 40
Master packaging type: Bulk
Product with gross packaging weight [kg]: 17.84

AVAILABLE VARIANTS

1000 mm, 2000 mm, 3000 mm, 4050 mm

Matching elements

DIFFUSERS



END CAPS



end cap PEN8 with hole silver [20pcs]
index: 86470040



end cap PEN8 with hole grey [20pcs]
index: 86470022



end cap PEN8 silver [20pcs]
index: 86490040



end cap PEN8 grey [20pcs]
index: 86490022

MOUNTING PLATES



holder PEN8 simple /plastic bag [2pcs]
index: 86370030



holder PEN8 flat grey [20pcs]
index: 86070022



(EOL) holder PEN8 stretcher
index: 86290003



holder PEN8 ring sur.
index: 86440000



(EOL) holder PEN8 jointed with ceiling
index: 86080003



(EOL) holder PEN8 jointed with thread
index: 86090003



(EOL) end holder PEN8
index: 86160003



(EOL) holder PEN8 jointed 200mm with ceiling
index: 86100003



(EOL) double holder PEN8 100mm with thread
index: 86330003