

LED PROFILE FLAT8 H/UX 4050 BLACK ANOD. /PLASTIC BAG



Architectural



max 8 mm



Recessed



- flat recessed profile emitting diffused light glow
- decorative illumination
- a parabolic, reflecting element
- even, smooth, diffused light
- a flat profile, designed to fit into plasterboards - installation without interference in the frame construction



EU industrial designs



CE



Made in Poland



Buy product

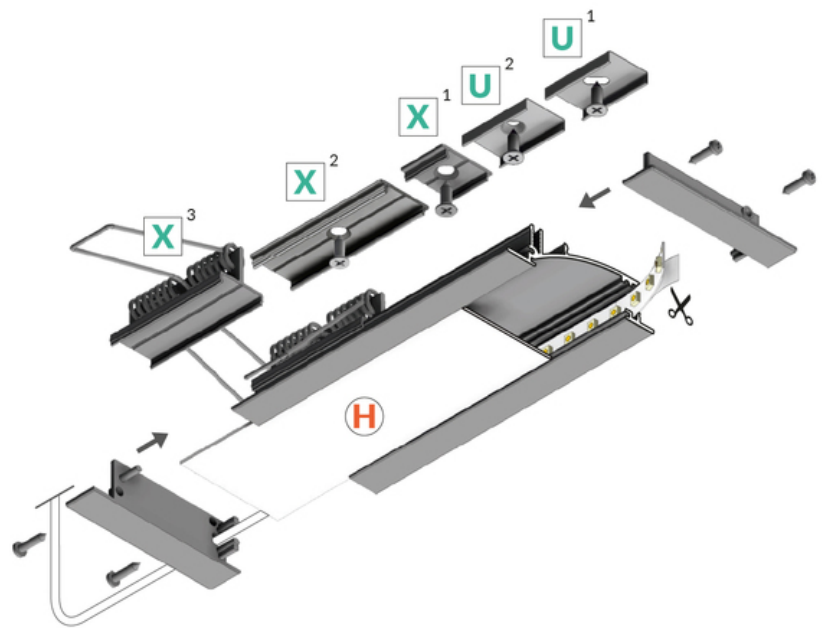
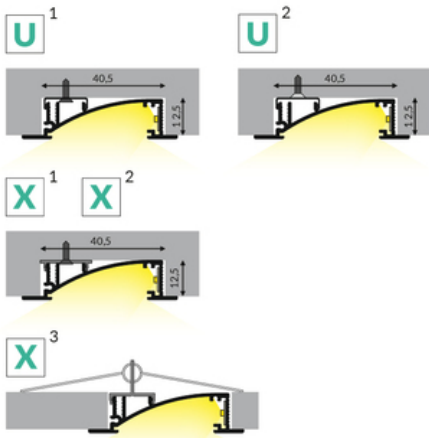
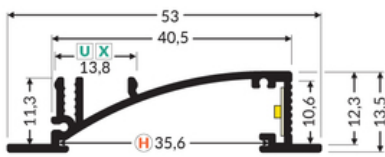

TOPMET LIGHT KŁOSOWICZ WIŚNIEWSKI sp. z o.o.

Ostrowska 354 | 61-312 Poznań | POLAND

tel.: +48 61 872 75 00

info@topmet.pl

pdf card generation date: 13.06.2026



TOPMET



Basic Informations

<p>EAN: 5901597250302 Index: 23210021 Material: aluminium Color: black anodized Length [mm]: 4050 Weight [kg]: 1.284 Net weight [kg]: 0.024 Country of origin: PL</p>	<p>Measurement unit: qty Product packaging dimensions [mm]: 4050 x 53 x 13,5 Bulk packing [qty]: 10 Master packaging type: Bulk Product with gross packaging weight [kg]: 12.84</p>
---	---

AVAILABLE COLORS

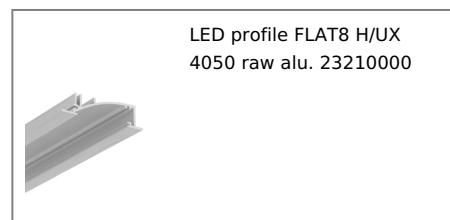
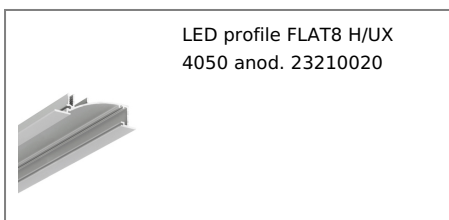

AVAILABLE VARIANTS

1000 mm, 2000 mm, 3000 mm, 4050 mm

Matching elements

DIFFUSERS



MOUNTINGS





TOPMET LIGHT KŁOSOWICZ WIŚNIEWSKI sp. z o.o.

Ostrowska 354 | 61-312 Poznań | POLAND

tel.: +48 61 872 75 00

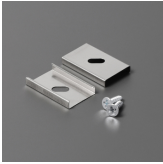
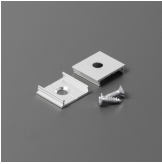
info@topmet.pl

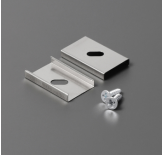
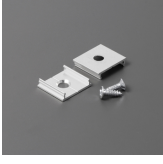

pdf card generation date: 13.06.2026

 <p>mounting plate U inox [500pcs] index: 76380000W</p>	 <p>mounting plate X [500pcs] index: 76260000W</p>	 <p>mounting plate U cone inox [500pcs] index: 76620000W</p>
 <p>mounting plate U cone inox [20pcs] index: 76620000</p>	 <p>mounting plate U inox [20pcs] index: 76380000</p>	 <p>mounting plate X [20pcs] index: 76260000</p>
 <p>mounting magnetic plate U inox [1pcs] index: 76999919</p>	 <p>mounting magnetic plate U inox [10pcs] index: 76999819</p>	

END CAPS

 <p>end cap FLAT8 with hole black [20pcs] index: 23110002</p>

CONNECTORS

 <p>connector X 180deg /plastic bag [1pc] index: 76350000</p>	 <p>connector X 180deg /plastic bag [200pc] index: 76350000W</p>
---	--

MOUNTING PLATES



mounting plate X spring
/plastic bag [1pcs]
index: 23130000