

LED PROFILE LINEA-IN20 EE7F/U7 4050 BLACK ANOD. /PLASTIC BAG



Recessed



Architectural

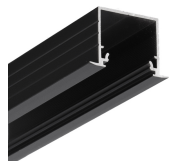

- continuous line of light (when using LED strip 120 P/m and opal diffuser)
- angled connections illuminated
- over 20 accessories available

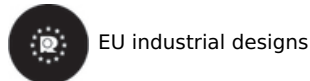

EU industrial designs



CE



Made in Poland



Buy product

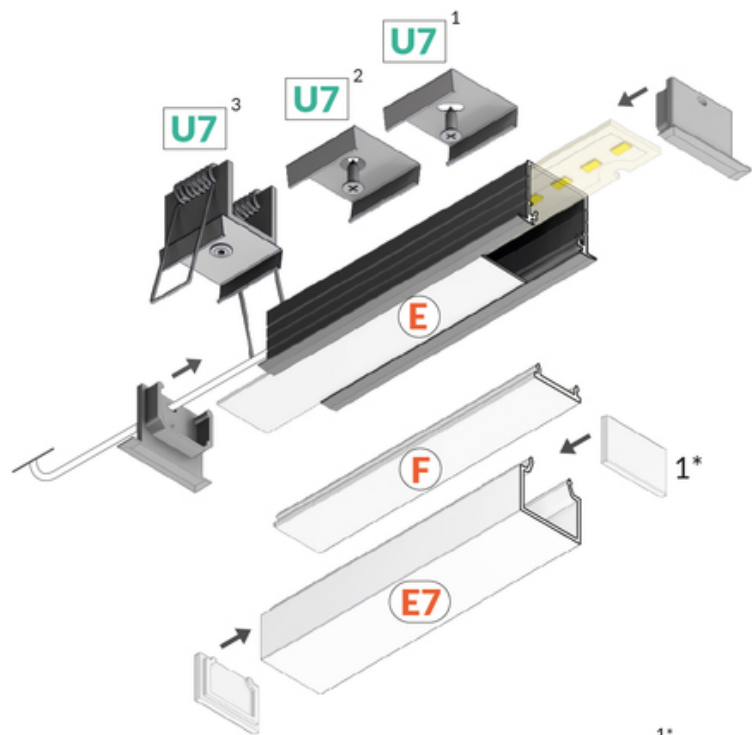
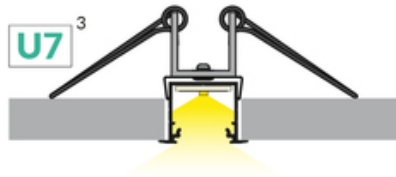
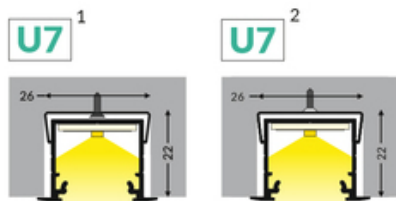
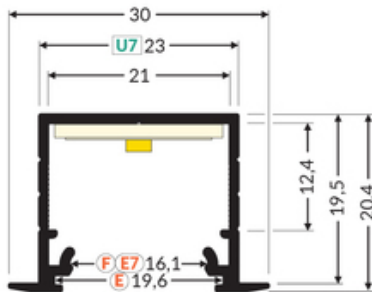

1*
end cap E7
zaślepka E7

TOPMET LIGHT KŁOSOWICZ WIŚNIEWSKI sp. z o.o.

Ostrowska 354 | 61-312 Poznań | POLAND

tel.: +48 61 872 75 00

info@topmet.pl

pdf card generation date: 16.06.2026



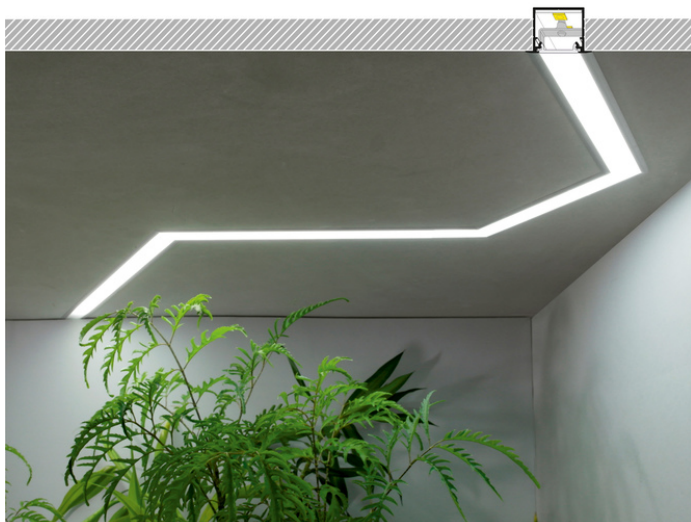

Basic Informations

EAN: 5901597251002
 Index: E4040021
 Material: aluminium
 Color: black anodized
 Length [mm]: 4050
 Weight [kg]: 0.907
 Net weight [kg]: 0.024
 Country of origin: PL

Measurement unit: qty
 Product packaging dimensions [mm]: 4050 x 30 x 20,4
 Bulk packing [qty]: 10
 Master packaging type: Bulk
 Product with gross packaging weight [kg]: 9.07

AVAILABLE COLORS

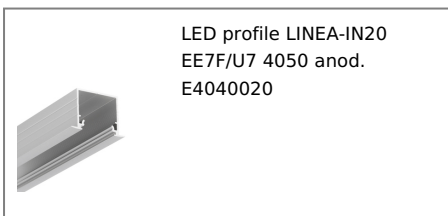

AVAILABLE VARIANTS

1000 mm, 2000 mm, 3000 mm, 4050 mm

Matching elements

DIFFUSERS

TOPMET LIGHT KŁOSOWICZ WIŚNIEWSKI sp. z o.o.
 Ostrowska 354 | 61-312 Poznań | POLAND
 tel.: +48 61 872 75 00
 info@topmet.pl

pdf card generation date: 16.06.2026



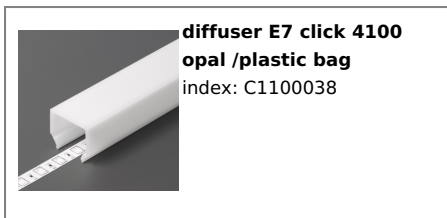

**diffuser E7 click 4100
opal /plastic bag**
index: C1100038

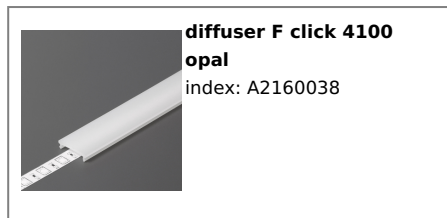

**diffuser F click 4100
opal**
index: A2160038



**diffuser F click 4100
transparent**
index: A2160016



**diffuser F click 4100
black**
index: A2160041



**diffuser F click 20m reel
opal /pack**
index: A2210038S



**diffuser E slide 2000
opal**
index: A2000238



**diffuser E slide 2000
frosted**
index: A2000239

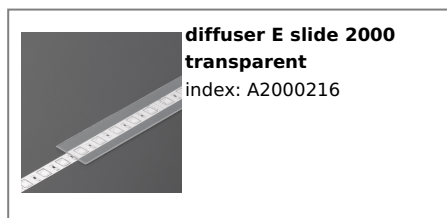

**diffuser E slide 2000
transparent**
index: A2000216

END CAPS



**end cap LINEA-IN20 with
hole black [20pcs]**
index: E4990002



**end cap LINEA-IN20-E7
with hole black [20pcs]**
index: E4999902

CONNECTORS



**connector LINEA-IN20
60deg black anod.
/plastic bag**
index: E4890021S



**connector LINEA-IN20
90deg black anod.
/plastic bag**
index: E4900021S



**connector LINEA-IN20
90deg bent black anod.
/plastic bag**
index: E4910021S



**connector LINEA-IN20
120deg black anod.
/plastic bag**
index: E4920021S

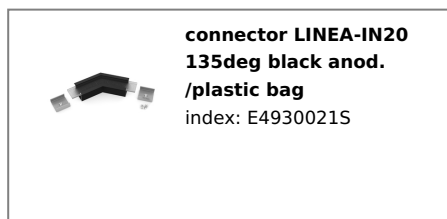

**connector LINEA-IN20
135deg black anod.
/plastic bag**
index: E4930021S

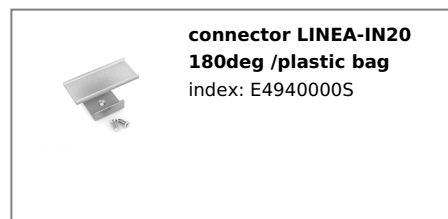

**connector LINEA-IN20
180deg /plastic bag**
index: E4940000S



connector LINEA-IN20
270deg bent black anod.
/plastic bag
index: E4950021S

OTHER



LED clamp LINEA20
white painted [20pcs]
index: C6940001



LINEA20-1 LED clamp
white [20pcs]
index: C6930001