

LED PROFILE GROOVE14 EE7F/TY 4050 ANOD.







Furniture



max 14 mm



Recessed

	<ul style="list-style-type: none"> used mainly in furniture many accessories available 	<ul style="list-style-type: none">  EU industrial designs  CE  Made in Poland 	 <p>Buy product</p>
---	--	---	--

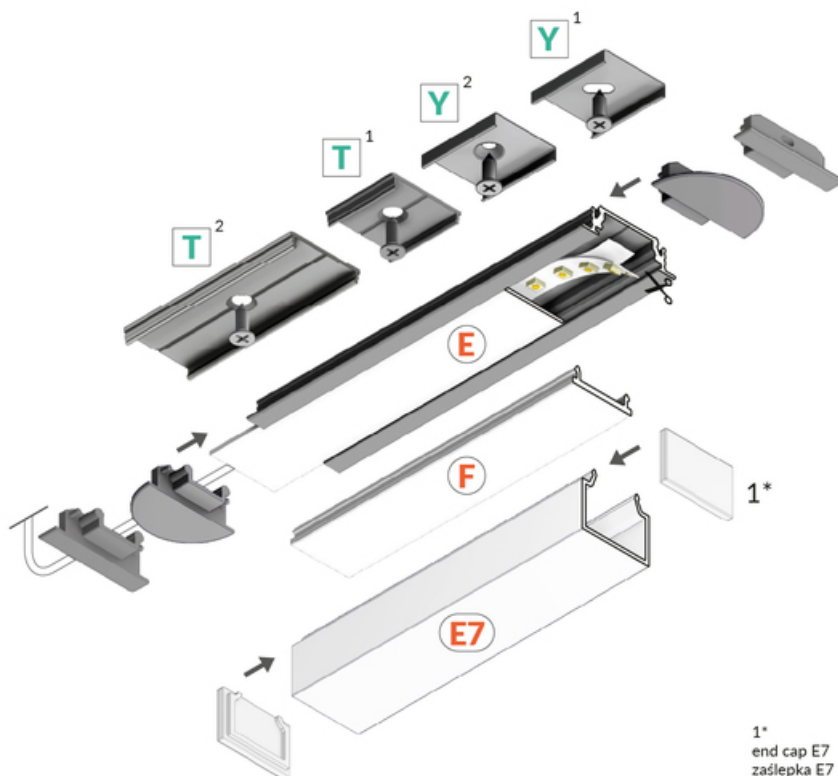
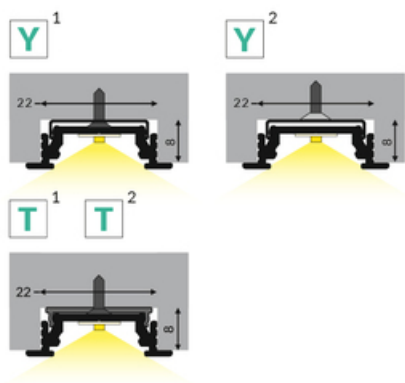
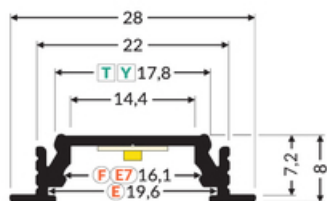

1*
end cap E7
zaślepka E7

TOPMET LIGHT KŁOSOWICZ WIŚNIEWSKI sp. z o.o.

Ostrowska 354 | 61-312 Poznań | POLAND

tel.: +48 61 872 75 00

info@topmet.pl

pdf card generation date: 16.06.2026







Basic Informations

<p>EAN: 5901597250647 Index: A3120020 Material: aluminium Color: anodized Length [mm]: 4050 Weight [kg]: 0.603 Net weight [kg]: 0.012 Country of origin: PL</p>	<p>Measurement unit: qty Product packaging dimensions [mm]: 4050 x 28 x 8 Bulk packing [qty]: 40 Master packaging type: Bulk Product with gross packaging weight [kg]: 24.12</p>
--	--

AVAILABLE COLORS

 <p>LED profile GROOVE14 EE7F/TY 4050 black anod. /plastic bag A3120021</p>	 <p>LED profile GROOVE14 EE7F/TY 4050 raw alu. A3120000</p>	 <p>LED profile GROOVE14 EE7F/TY 4050 white painted RAL9003 /plastic bag A3120001</p>
--	--	---

AVAILABLE VARIANTS

1000 mm, 2000 mm, 3000 mm, 4050 mm

Matching elements

DIFFUSERS

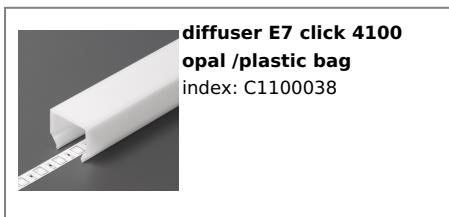

MOUNTINGS

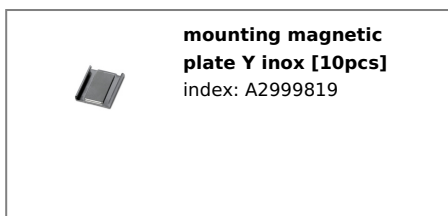
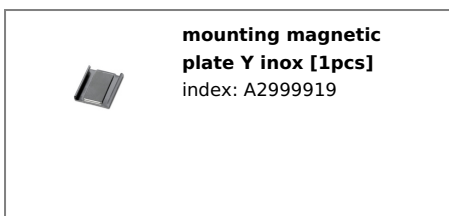
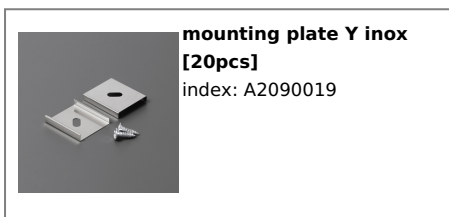
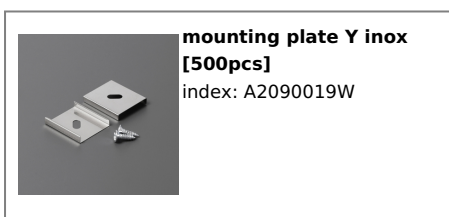

END CAPS



**end cap GROOVE14 gen2
with hole grey [20pcs]**
index: A3970022



**end cap GROOVE14 gen2
with hole silver [20pcs]**
index: A3970040



**end cap GROOVE14 gen2
SQ with hole grey
[20pcs]**
index: A3980022



**end cap GROOVE14 gen2
SQ with hole silver
[20pcs]**
index: A3980040

CONNECTORS



**connector GROOVE14
90deg anod. /plastic bag**
index: A3990020



**connector T 180deg
/plastic bag**
index: C6990000



**connector T 180deg
/plastic bag [200pcs]**
index: C6990000W