

LED PROFILE DIAGONAL14 F/TY 3000 ANOD.



Recessed







Furniture



max 14 mm



Corner

	<ul style="list-style-type: none"> • reduced glare effect • used mainly in furniture 	<p>  CE  EU industrial designs  Made in Poland </p>	 <p>Buy product</p>
---	--	--	--

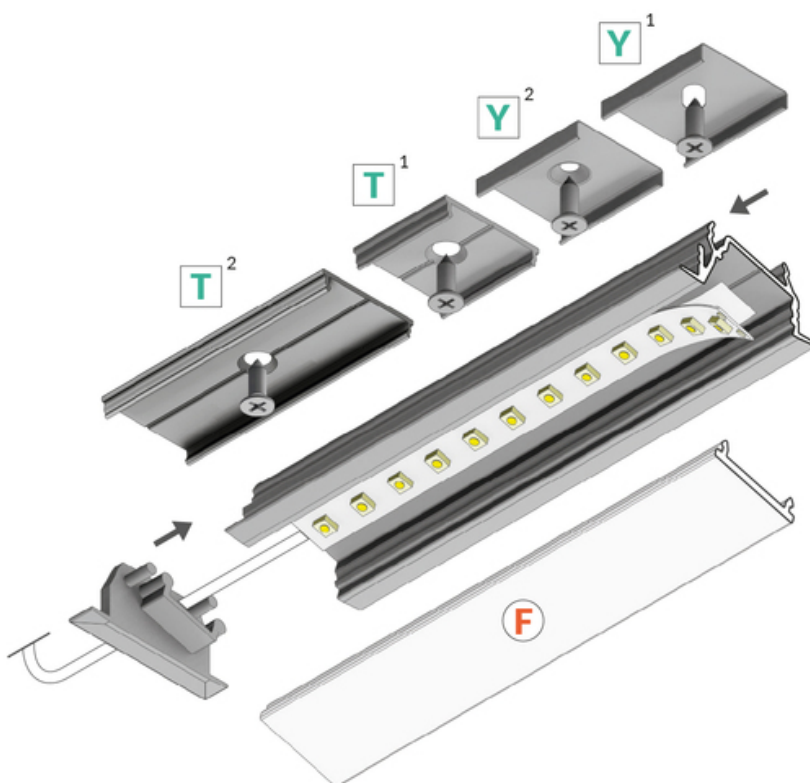
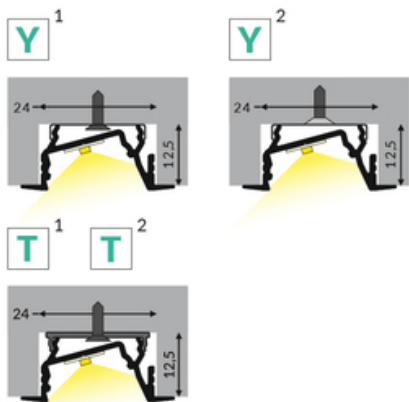
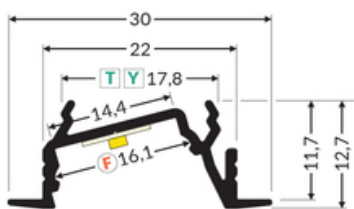

TOPMET LIGHT KŁOSOWICZ WIŚNIEWSKI sp. z o.o.

Ostrowska 354 | 61-312 Poznań | POLAND

tel.: +48 61 872 75 00

info@topmet.pl

pdf card generation date: 01.07.2026





Basic Informations

EAN: 5901597284215
 Index: H5090020
 Material: aluminium
 Color: anodized
 Length [mm]: 3000
 Weight [kg]: 0.459
 Net weight [kg]: 0.012
 Country of origin: PL

Measurement unit: qty
 Product packaging dimensions [mm]: 3000 x 30 x 12,7
 Bulk packing [qty]: 40
 Master packaging type: Bulk
 Product with gross packaging weight [kg]: 18.36

AVAILABLE COLORS

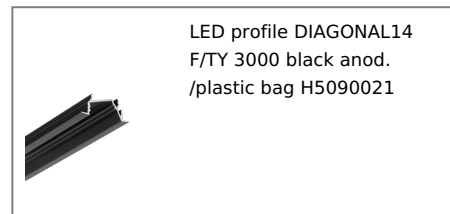
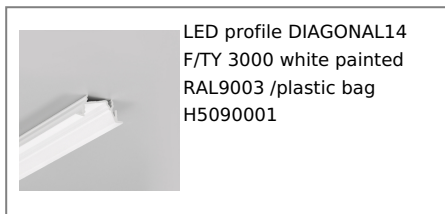
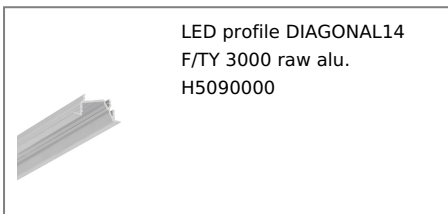

AVAILABLE VARIANTS

1000 mm, 2000 mm, 3000 mm, 4050 mm

Matching elements

DIFFUSERS



MOUNTINGS

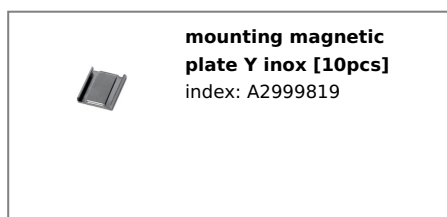
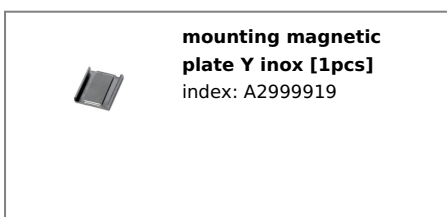
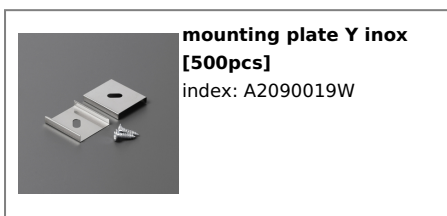

END CAPS



CONNECTORS

TOPMET LIGHT KŁOSOWICZ WIŚNIEWSKI sp. z o.o.

Ostrowska 354 | 61-312 Poznań | POLAND

tel.: +48 61 872 75 00

info@topmet.pl

pdf card generation date: 01.07.2026



connector T 180deg
/plastic bag

index: C6990000



connector T 180deg
/plastic bag [200pcs]

index: C6990000W