

LED PROFILE HIDE10 C4 PLUS 3000 ANOD.







Spackle in



Architectural

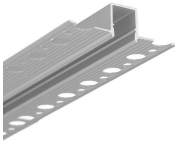

max 10 mm

	<ul style="list-style-type: none">• profile that fits into the thickness of a standard plasterboard (12,5 mm)• continuous line of light when using LED strip 120 P/m	 EU industrial designs  CE  Made in Poland	 Buy product
---	---	---	--

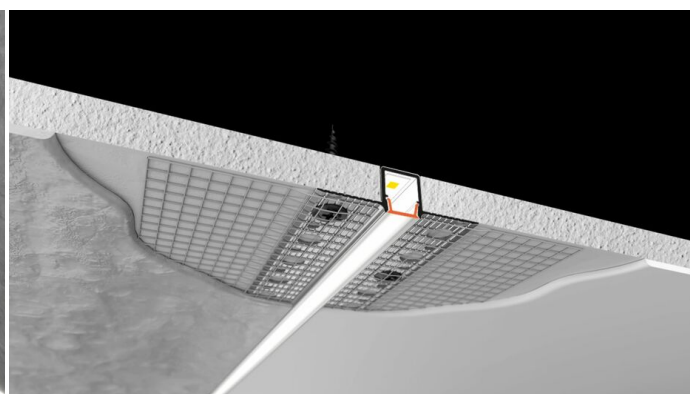
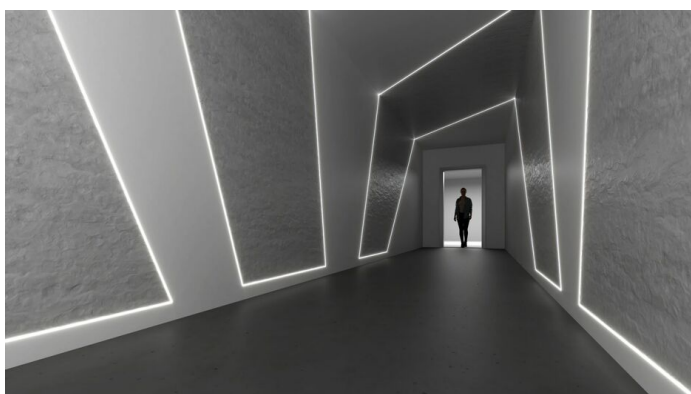
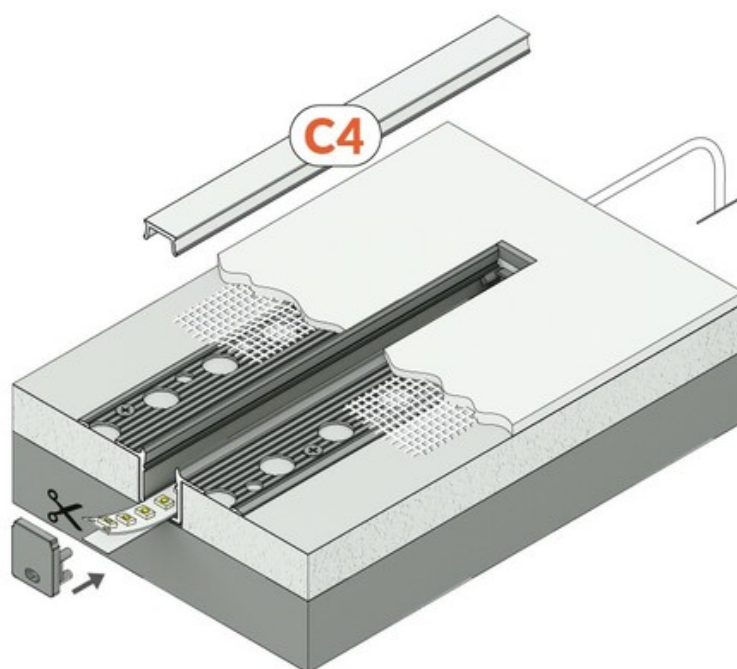

Basic Informations

Material: aluminium Color: anodized Length [mm]: 3000 Weight [kg]: 0.657 Country of origin: PL	Measurement unit: qty Product packaging dimensions [mm]: 3000 x 50,4 x 14,7 Bulk packing [qty]: 40 Master packaging type: Bulk Product with gross packaging weight [kg]: 26.28
--	--

AVAILABLE COLORS

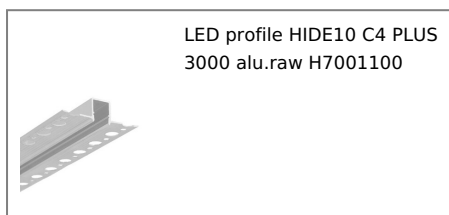

AVAILABLE VARIANTS

1000 mm, 2000 mm, 3000 mm, 4050 mm

Matching elements

DIFFUSERS

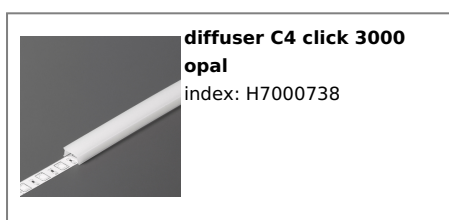

END CAPS

TOPMET LIGHT KŁOSOWICZ WIŚNIEWSKI sp. z o.o.

Ostrowska 354 | 61-312 Poznań | POLAND

tel.: +48 61 872 75 00

info@topmet.pl

pdf card generation date: 30.06.2026



**end cap HIDE10 with
hole grey [20pcs]**
index: H7999922