

LED PROFILEHIDE10 C4 PLUS 4050 ALU.RAW







Spackle in



Architectural

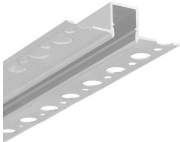

max 10 mm

	<ul style="list-style-type: none">• profile that fits into the thickness of a standard plasterboard (12,5 mm)• continuous line of light when using LED strip 120 P/m	<p> CE</p> <p> EU industrial designs</p> <p> Made in Poland</p>	 <p>Buy product</p>
---	---	--	--

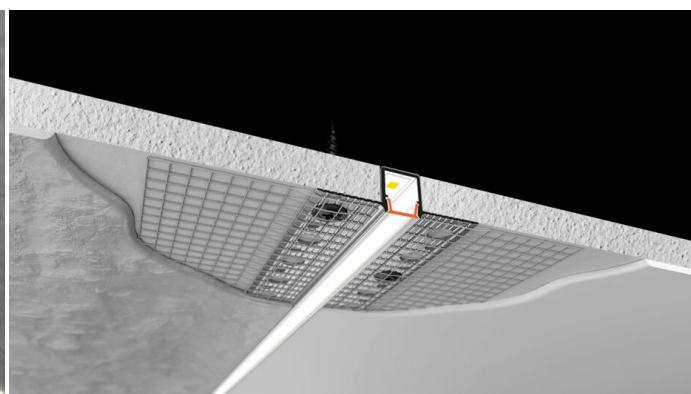
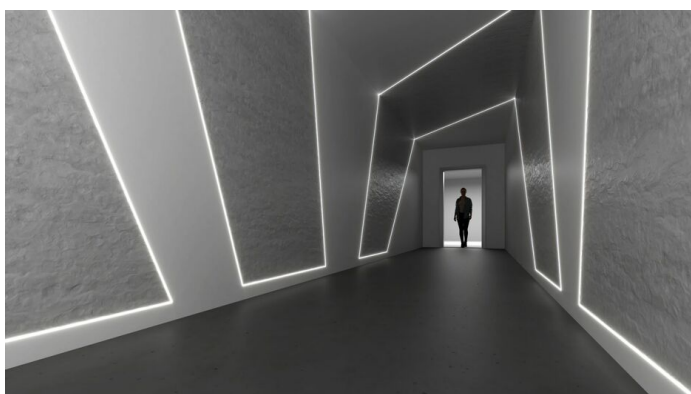
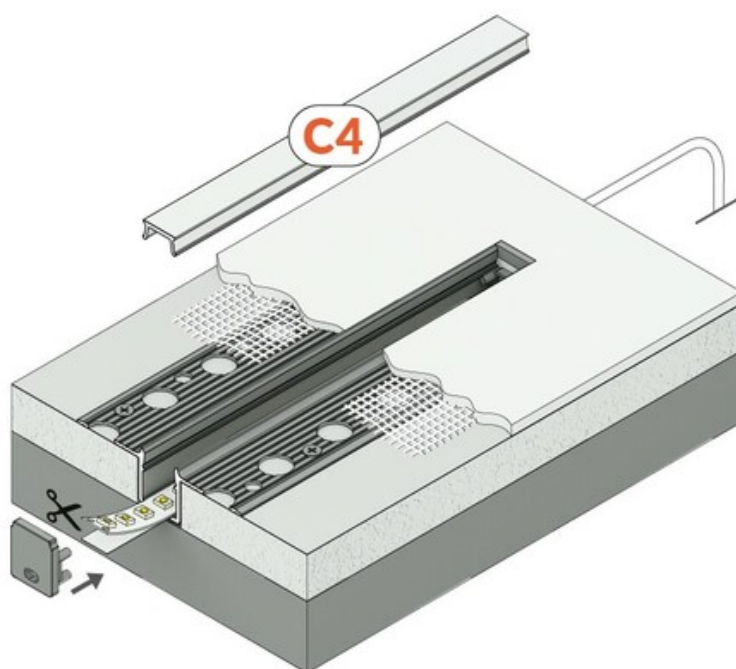

Basic Informations

Material: aluminium Color: raw aluminium Length [mm]: 4050 Weight [kg]: 0.887 Country of origin: PL	Measurement unit: qty Product packaging dimensions [mm]: 4050 x 50,4 x 14,7 Bulk packing [qty]: 40 Master packaging type: Bulk Product with gross packaging weight [kg]: 35.48
---	--

AVAILABLE COLORS

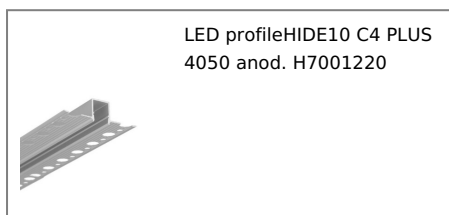

AVAILABLE VARIANTS

1000 mm, 2000 mm, 3000 mm, 4050 mm

Matching elements

DIFFUSERS

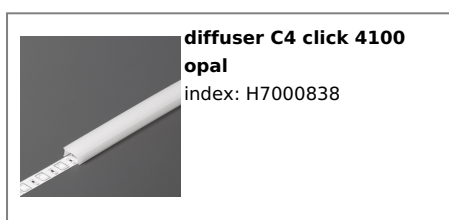

END CAPS

TOPMET LIGHT KŁOSOWICZ WIŚNIEWSKI sp. z o.o.

Ostrowska 354 | 61-312 Poznań | POLAND

tel.: +48 61 872 75 00

info@topmet.pl

pdf card generation date: 30.06.2026



**end cap HIDE10 with
hole grey [20pcs]**
index: H7999922