

LED PROFILE NAMI23 CD-9 2000 GOLD ANOD. /PLASTIC BAG

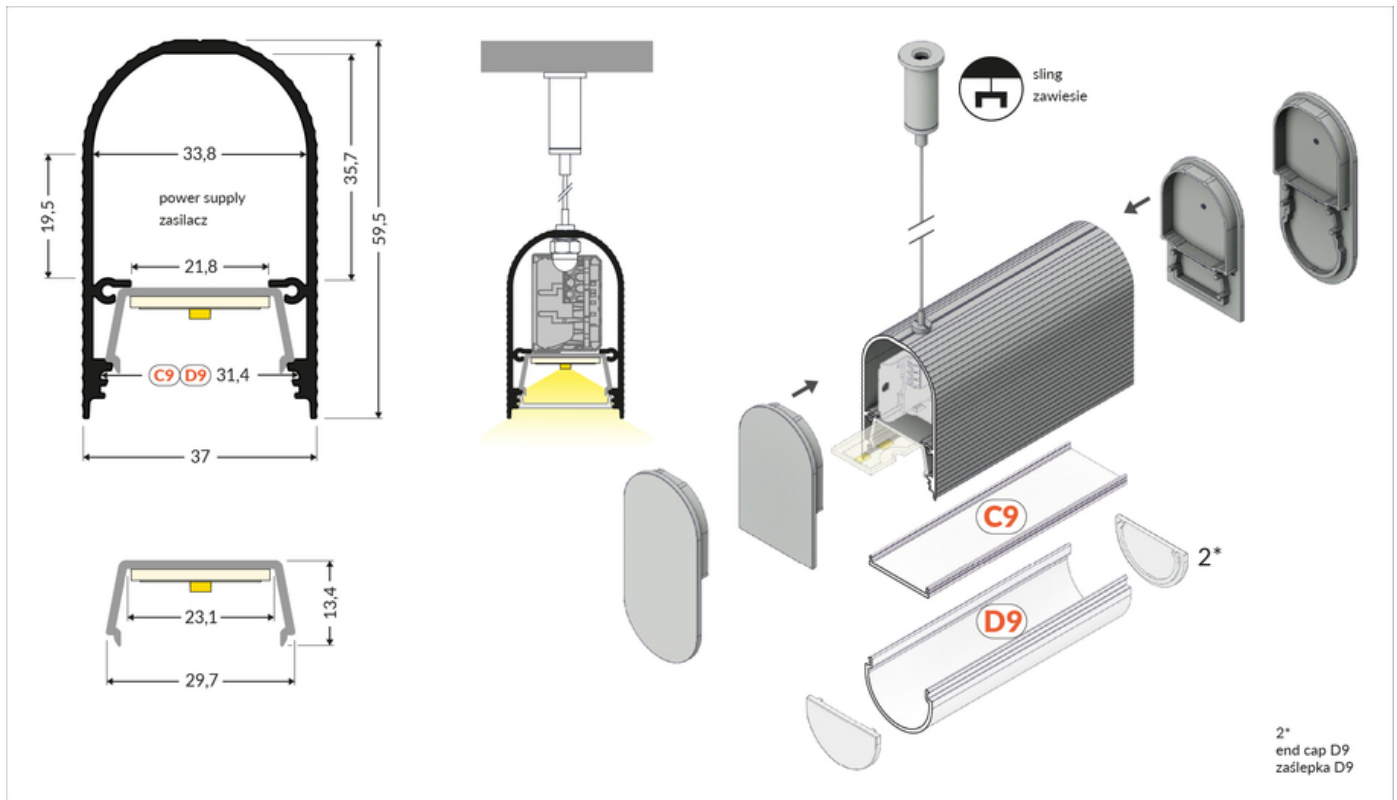

	<p> CE</p> <p> EU industrial designs</p> <p> Made in Poland</p>	 <p>Buy product</p>
---	--	--

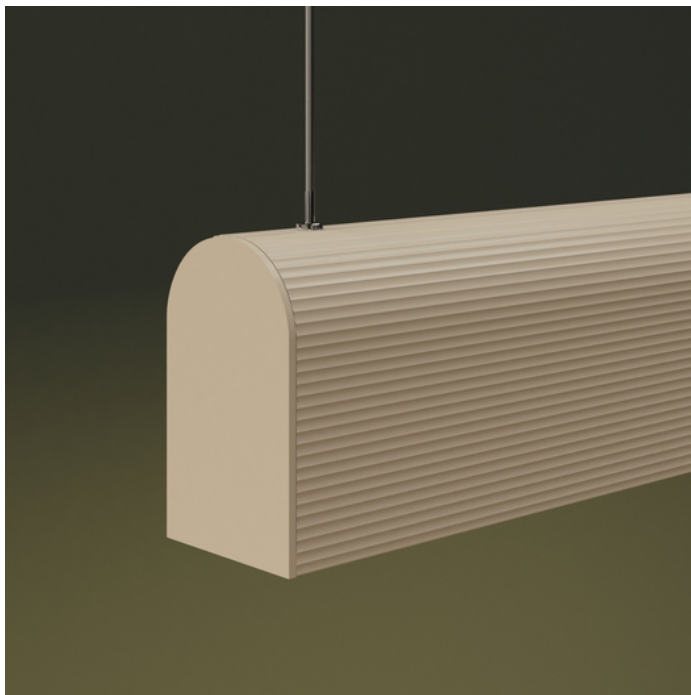







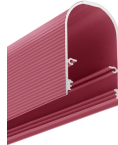

Basic Informations

Material: aluminium Lenght [mm]: 2000 Weigh [kg]: 1.348 Net weight [kg]: 0.015 Country of origin: PL	Measurement unit: qty Product packaging dimensions [mm]: 2000 x 37 x 59,5 Bulk packing [qty]: 10 Master packaging type: Bulk Product with gross packaging weight [kg]: 13.48
--	--

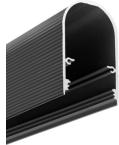
AVAILABLE COLORS

 <p>LED profile NAMI23 CD-9 2000 white painted RAL9003 /plastic bag K1000201</p>	 <p>LED profile NAMI23 CD-9 2000 titanium blue painted RAL 250 50 15 /plastic bag K1000297</p>	 <p>LED profile NAMI23 CD-9 2000 black anod. /plastic bag K1000221</p>
 <p>LED profile NAMI23 CD-9 2000 slate pink painted RAL 010 50 40 /plastic bag K1000295</p>	 <p>LED profile NAMI23 CD-9 2000 almond beige painted RAL 070 85 05 /plastic bag K1000296</p>	 <p>LED profile NAMI23 CD-9 2000 medium black painted RAL 000 30 00 /plastic bag K1000294</p>
 <p>LED profile NAMI23 CD-9 2000 raw alu. K1000200</p>		

AVAILABLE VARIANTS

1000 mm, 2000 mm, 3000 mm, 4050 mm

Matching elements

DIFFUSERS

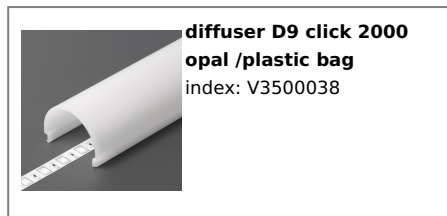

MOUNTINGS

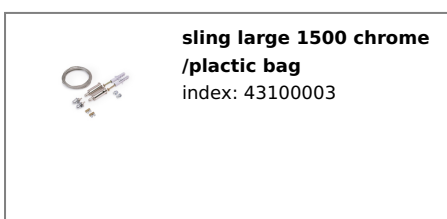

END CAPS

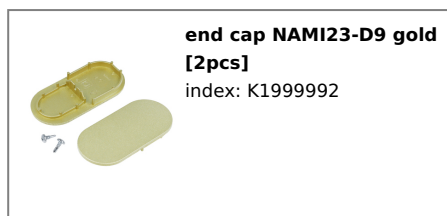
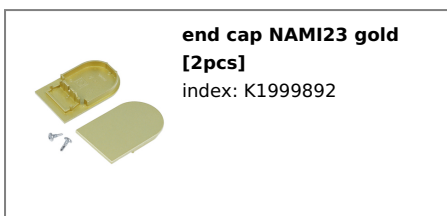

COMPLEMENTARY PROFILE

