

LED PROFILE NAMI23 CD-9 1000 GOLD ANOD. /PLASTIC BAG



Lighting



max 23 mm



EU industrial designs



CE



Made in Poland



Buy product

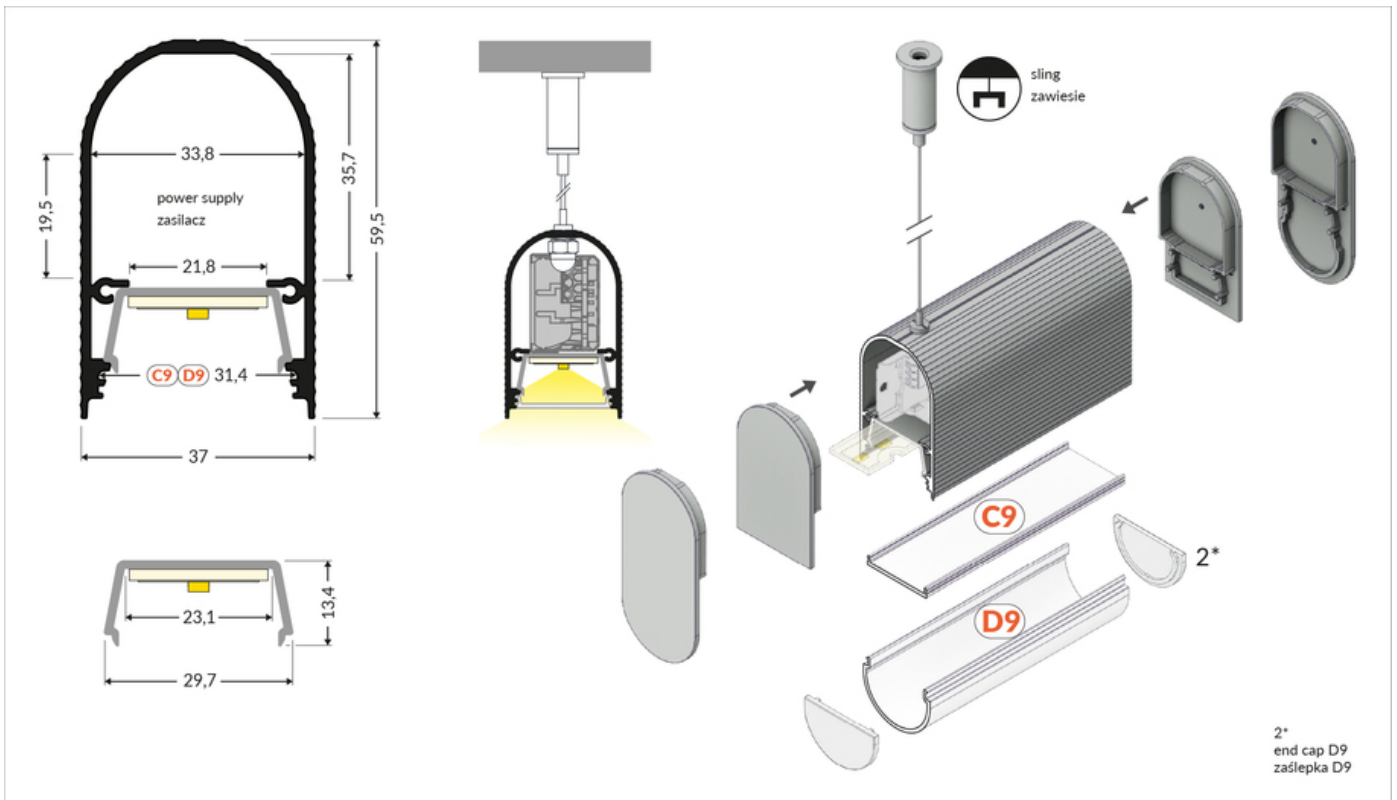

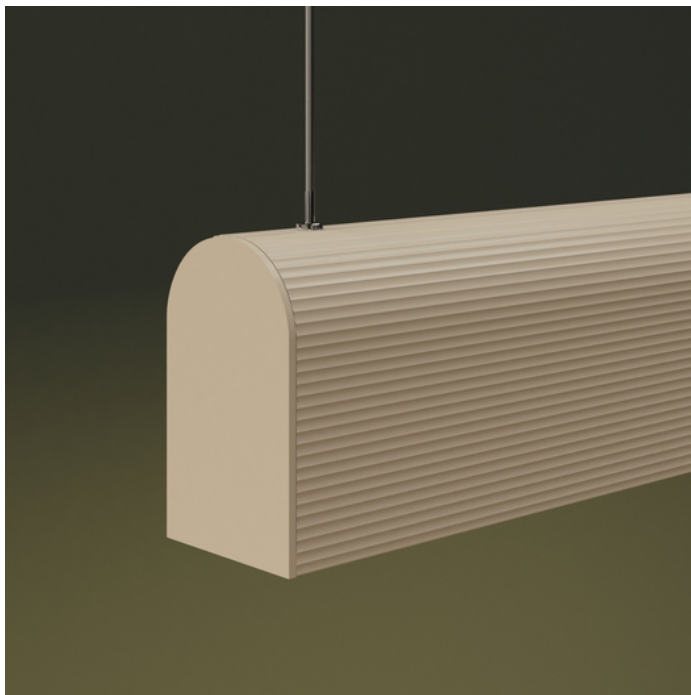



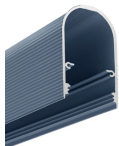

Basic Informations

Material: aluminium Lenght [mm]: 1000 Weigh [kg]: 0.674 Net weight [kg]: 0.015 Country of origin: PL	Measurement unit: qty Product packaging dimensions [mm]: 1000 x 37 x 59,5 Bulk packing [qty]: 10 Master packaging type: Bulk Product with gross packaging weight [kg]: 6.74
--	---

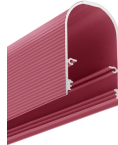
AVAILABLE COLORS

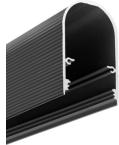
 <p>LED profile NAMI23 CD-9 1000 white painted RAL9003 /plastic bag K1000101</p>	 <p>LED profile NAMI23 CD-9 1000 titanium blue painted RAL 250 50 15 /plastic bag K1000197</p>	 <p>LED profile NAMI23 CD-9 1000 black anod. /plastic bag K1000121</p>
 <p>LED profile NAMI23 CD-9 1000 slate pink painted RAL 010 50 40 /plastic bag K1000195</p>	 <p>LED profile NAMI23 CD-9 1000 almond beige painted RAL 070 85 05 /plastic bag K1000196</p>	 <p>LED profile NAMI23 CD-9 1000 medium black painted RAL 000 30 00 /plastic bag K1000194</p>
 <p>LED profile NAMI23 CD-9 1000 raw alu. K1000100</p>		

AVAILABLE VARIANTS

1000 mm, 2000 mm, 3000 mm, 4050 mm

Matching elements

DIFFUSERS



**diffuser C9 click 1000
black /plastic bag**
index: V3450041

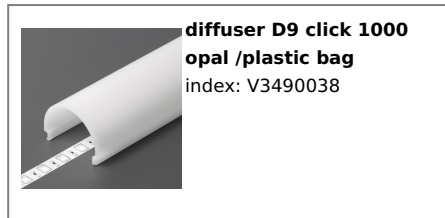

**diffuser D9 click 1000
opal /plastic bag**
index: V3490038



**diffuser C9 click 20m
reel black**
index: V3000441S



**diffuser C9 click IRM
20m reel opal**
index: V3000938S



**diffuser C9 click IRM
1000 transparent**
index: V3000516

MOUNTINGS

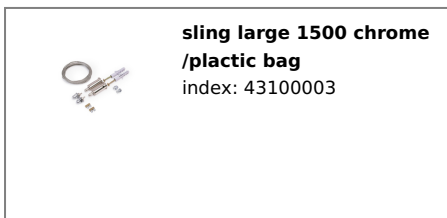

**sling large 1500 chrome
/plactic bag**
index: 43100003

END CAPS

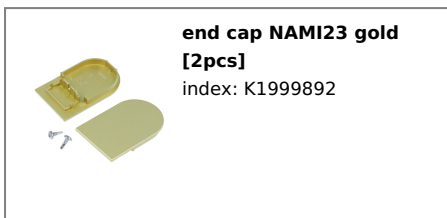

**end cap NAMI23 gold
[2pcs]**
index: K1999892

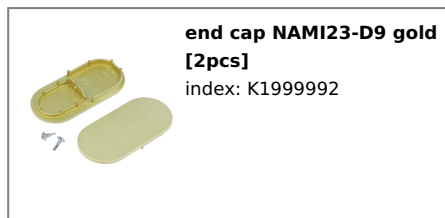

**end cap NAMI23-D9 gold
[2pcs]**
index: K1999992

COMPLEMENTARY PROFILE

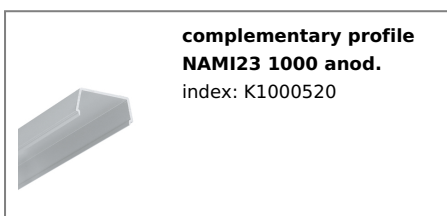

**complementary profile
NAMI23 1000 anod.**
index: K1000520