

LED PROFILE HOOD14 F/U1 4050 ANOD.



Surface



Furniture



max 14 mm

	<ul style="list-style-type: none">  EU industrial designs  CE  Made in Poland 	 <p style="text-align: center;">Buy product</p>
---	---	--

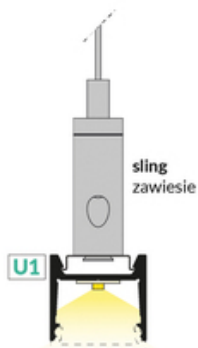
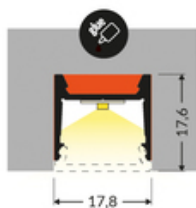
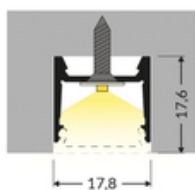
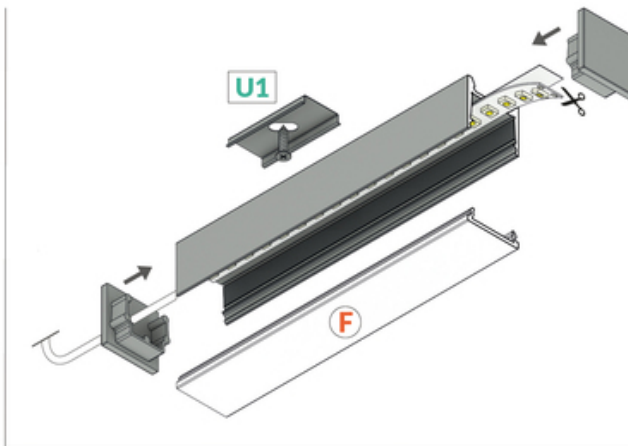
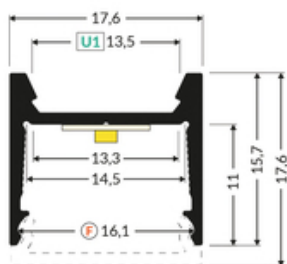



Basic Informations

Material: aluminium Color: anodized Length [mm]: 4050 Weight [kg]: 0.651 Country of origin: PL	Measurement unit: qty Bulk packing [qty]: 40 Master packaging type: Bulk
--	--

AVAILABLE COLORS

 <p>LED profile HOOD14 F/U1 4050 raw alu. L9000400</p>	 <p>LED profile HOOD14 F/U1 4050 white painted RAL9003 /plastic bag L9000401</p>	 <p>LED profile HOOD14 F/U1 4050 black anod. /plastic bag L9000421</p>
---	---	---

AVAILABLE VARIANTS

2000 mm, 4050 mm, 1000 mm, 3000 mm

Matching elements

DIFFUSERS

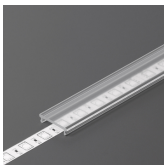
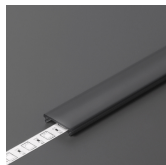
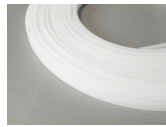
 <p>diffuser F click 4100 opal index: A2160038</p>	 <p>diffuser F click 4100 transparent index: A2160016</p>	 <p>diffuser F click 4100 black index: A2160041</p>
 <p>diffuser F click 20m reel opal /pack index: A2210038S</p>		

END CAPS

TOPMET LIGHT KŁOSOWICZ WIŚNIEWSKI sp. z o.o.

Ostrowska 354 | 61-312 Poznań | POLAND

tel.: +48 61 872 75 00

info@topmet.pl

pdf card generation date: 29.06.2026



end cap HOOD14 silver
[20pcs]
index: L9999940



end cap HOOD14 grey
[20pcs]
index: L9999922

MOUNTING PLATES



mounting plate U1 inox
[20pcs]
index: J6999819