

LED PROFILE PHIL.V2 C10/Q9 4050 BLACK ANOD. /PLASTIC

BAG



EU industrial designs



CE



Made in Poland



Buy product

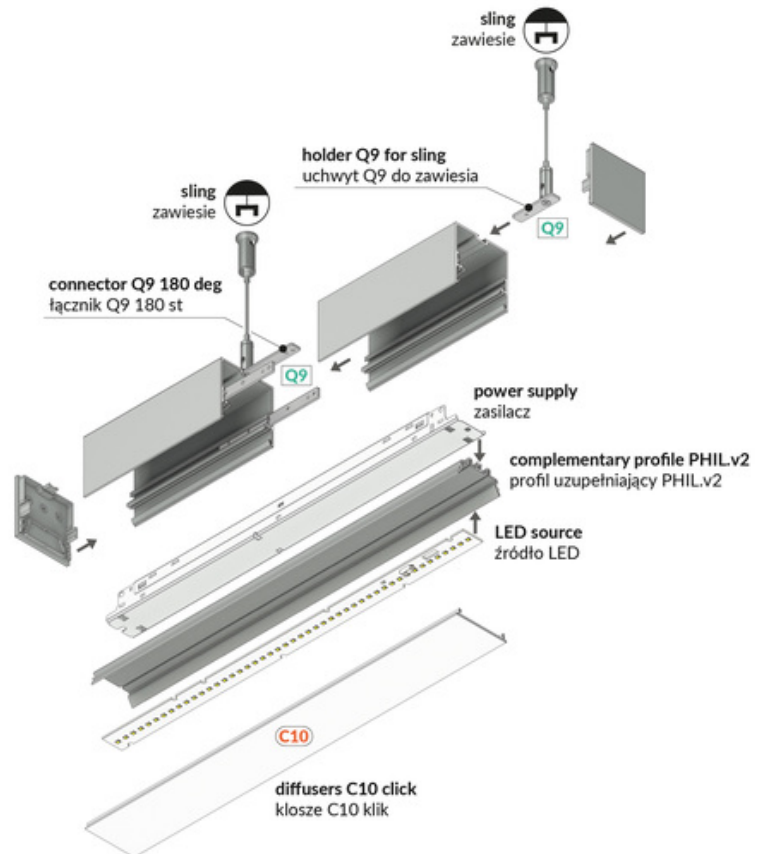
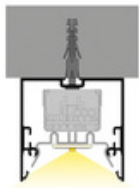
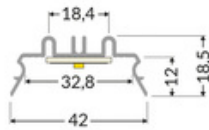
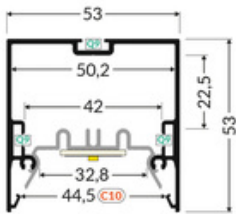

TOPMET LIGHT KŁOSOWICZ WIŚNIEWSKI sp. z o.o.

Ostrowska 354 | 61-312 Poznań | POLAND

tel.: +48 61 872 75 00

info@topmet.pl

pdf card generation date: 30.06.2026



CONNECTION POSSIBILITY MOŻLIWOŚCI ŁĄCZENIA

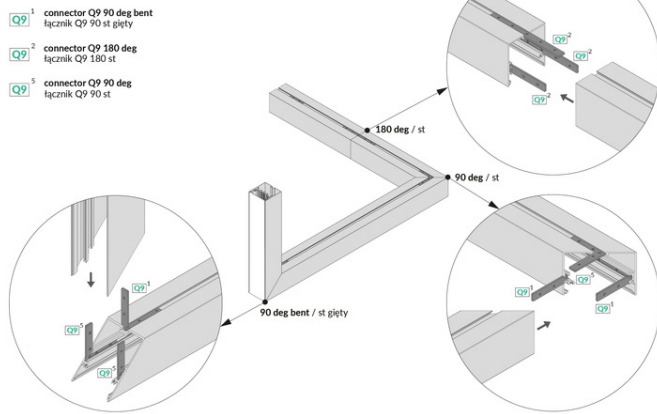

Basic Informations

EAN: 5901597217985 Index: P2000421 Material: aluminium Color: black anodized Length [mm]: 4050 Weight [kg]: 3.654 Net weight [kg]: 0.018 Country of origin: PL	Measurement unit: qty Product packaging dimensions [mm]: 4050 x 53 x 53 Bulk packing [qty]: 4 Master packaging type: Bulk Product with gross packaging weight [kg]: 14.616
-------------------------------------------------------------------------------------------------------------------------------------------------------------------------------------	----------------------------------------------------------------------------------------------------------------------------------------------------------------------------------------

AVAILABLE COLORS

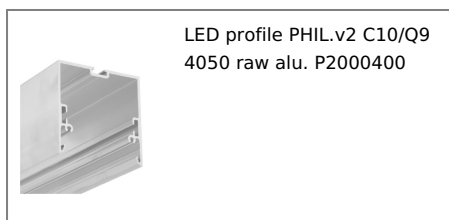

AVAILABLE VARIANTS

2000 mm, 4050 mm, 1000 mm, 3000 mm

Matching elements

DIFFUSERS

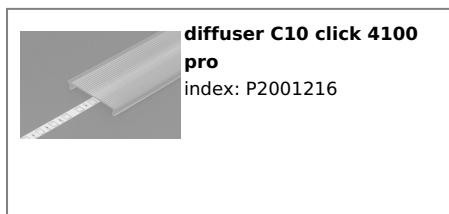
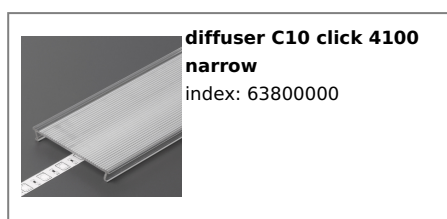

END CAPS



PHIL.v2 end cap black
[2pcs]
index: P2999902

CONNECTORS



connector Q9-180deg
/plastic bag
index: V5999819S



connector Q9-90deg
bent /plastic bag
index: V5999519S



connector Q9-90deg
/plastic bag
index: V5999419S

OTHER

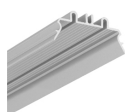

complementary profile
PHIL.v2 4050 anod.
index: P2000820

COMPLEMENTARY PROFILE



cover C10 4050 black
painting RAL9005 /plastic
bag
index: 63750002