

LED PROFILE UNI14 BC3/Y 4050 BLACK ANOD. /PLASTIC BAG



Surface



Furniture



max 14 mm

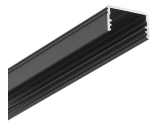

EU industrial designs



CE



Made in Poland



Buy product

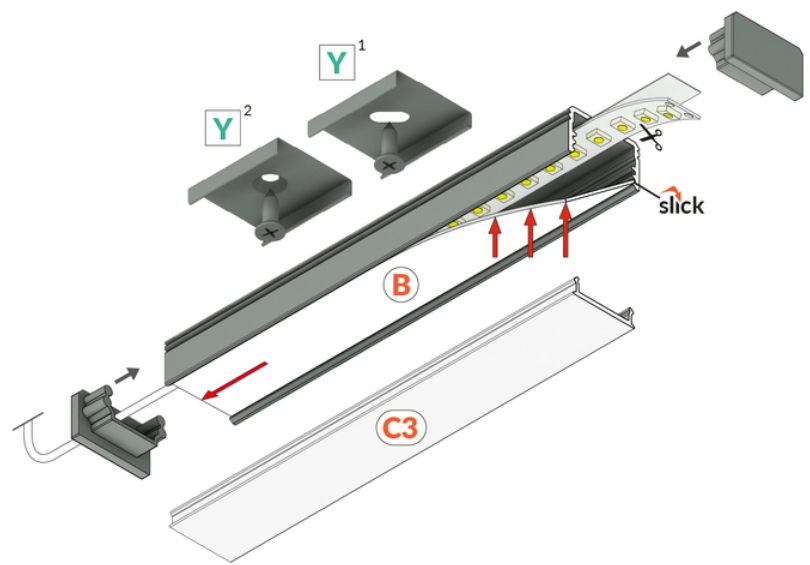
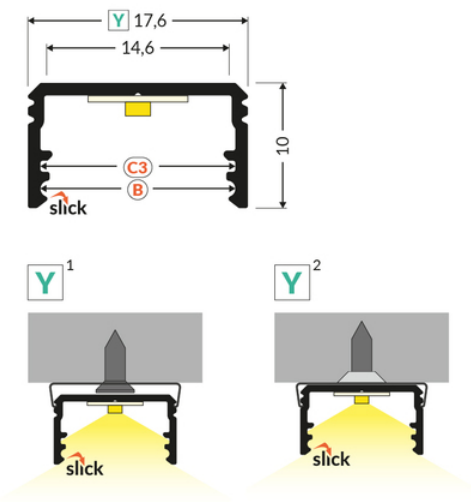

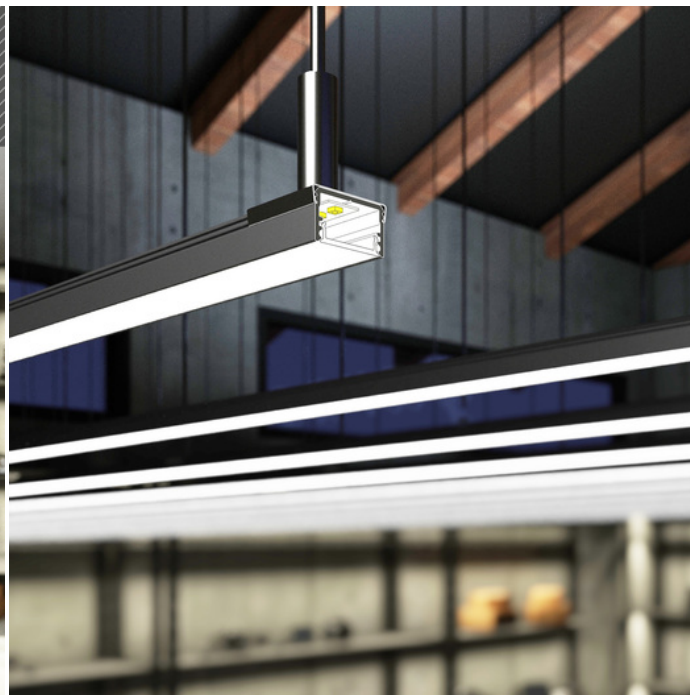
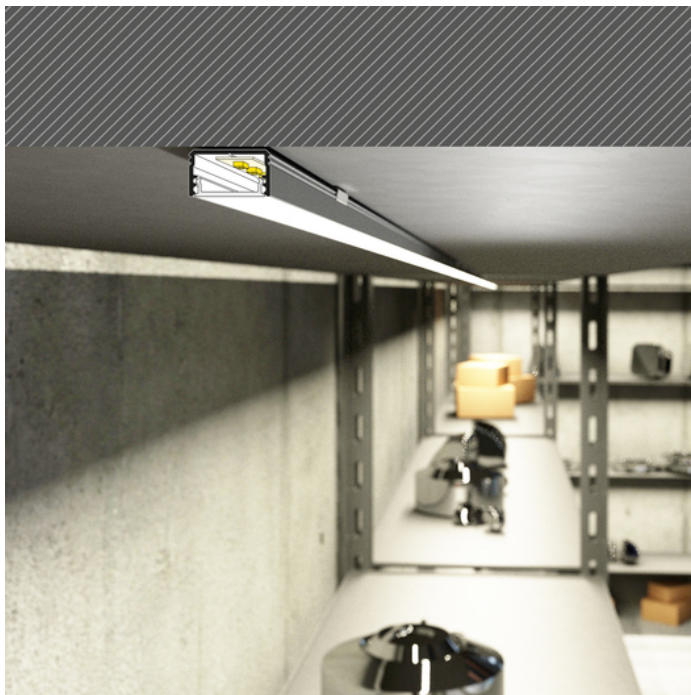

Basic Informations

EAN: 5901597262237

Index: L1000421

Material: aluminium

Color: black anodized

Length [mm]: 4050

Weight [kg]: 0.444

Net weight [kg]: 0.015

Country of origin: PL

Measurement unit: qty

Product packaging dimensions [mm]: 4050 x 17,6 x 10

Master packaging type: Bulk

AVAILABLE COLORS

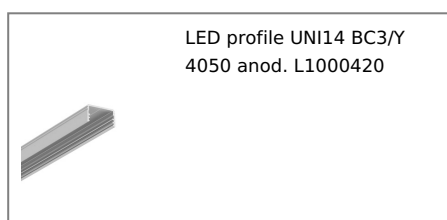
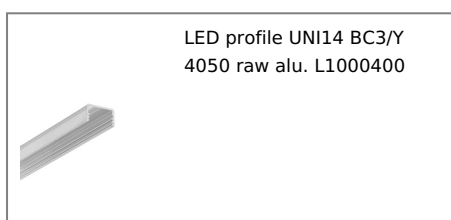

AVAILABLE VARIANTS

2000 mm, 4050 mm, 1000 mm, 3000 mm

Matching elements

TOPMET LIGHT KŁOSOWICZ WIŚNIEWSKI sp. z o.o.

Ostrowska 354 | 61-312 Poznań | POLAND

tel.: +48 61 872 75 00

info@topmet.pl

pdf card generation date: 28.06.2026

DIFFUSERS

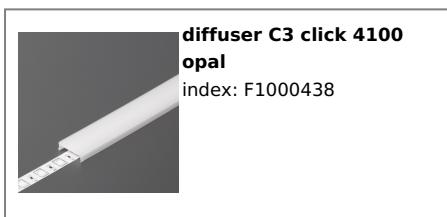

MOUNTINGS

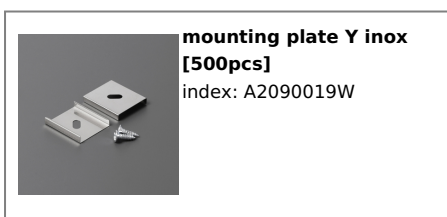

END CAPS

