

# LED PROFILE GROOVE10.V2 A1C/U 4050 ANOD.







Furniture



max 10 mm



Recessed

	<ul style="list-style-type: none"> <li>• a new generation of recessed profiles</li> <li>• basic and aesthetically pleasing furniture profile</li> <li>• shallow mounting hole depth</li> </ul>	<ul style="list-style-type: none"> <li> EU industrial designs</li> <li> CE</li> <li> Made in Poland</li> </ul>	 <p>Buy product</p>
---	--	---	--

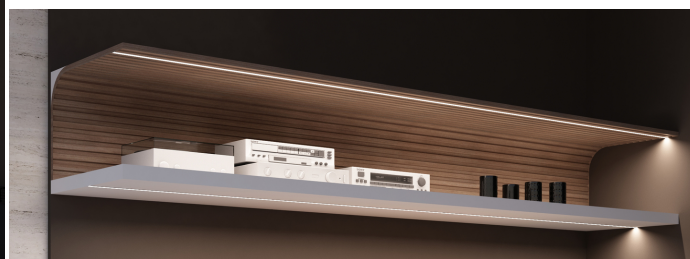
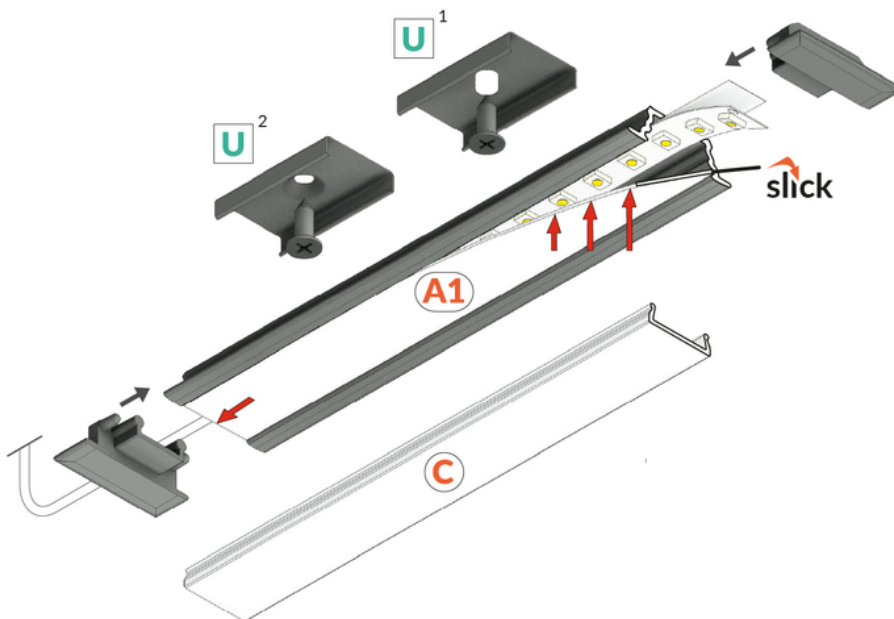
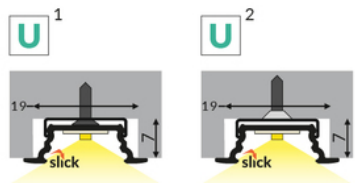
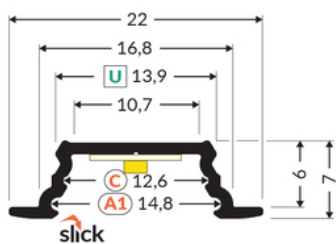



## Basic Informations

EAN: 5901597231745 Index: K5000420 Material: aluminium Color: anodized Length [mm]: 4050 Weight [kg]: 0.36 Net weight [kg]: 0.012 Country of origin: PL	Measurement unit: qty Product packaging dimensions [mm]: 4050 x 22 x 7 Bulk packing [qty]: 40 Master packaging type: Bulk Product with gross packaging weight [kg]: 14.4
--	--

## AVAILABLE COLORS





 <p>LED profile GROOVE10.v2 A1C/U 4050 raw alu. K5000400</p>	 <p>LED profile GROOVE10.v2 A1C/U 4050 white painted RAL9003 /plastic bag K5000401</p>	 <p>LED profile GROOVE10.v2 A1C/U 4050 black anod. /plastic bag K5000421</p>
---	---	---

## AVAILABLE VARIANTS

2000 mm, 4050 mm, 1000 mm, 3000 mm

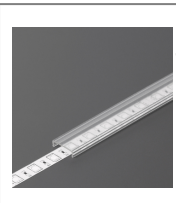
## Matching elements

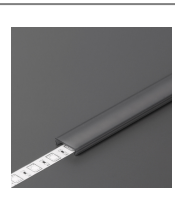
## DIFFUSERS

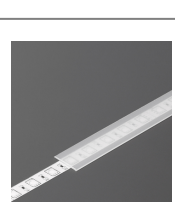
 <p><b>diffuser C click 4100 transparent</b> index: 76660000</p>	 <p><b>diffuser C click 4100 opal</b> index: 76660038</p>	 <p><b>diffuser C click 4100 black</b> index: 76660041</p>
 <p><b>diffuser C click 20m reel opal /pack</b> index: 76360038S</p>	 <p><b>diffuser A1 slide 2000 opal</b> index: J6000938</p>	 <p><b>diffuser A1 slide 2000 frosted</b> index: J6000939</p>

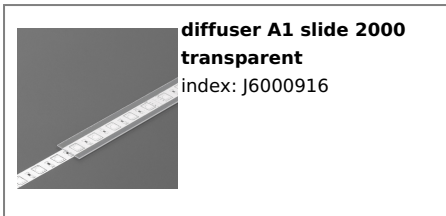

## MOUNTINGS

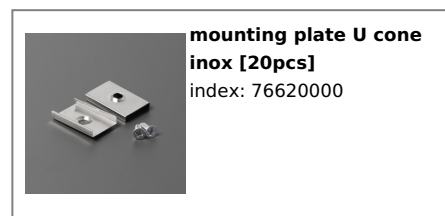

## END CAPS

