

LED PROFILE GROOVE10.V2 A1C/U 4050 WHITE PAINTED

RAL9003 /PLASTIC BAG



Recessed



Furniture



max 10 mm



- a new generation of recessed profiles
- basic and aesthetically pleasing furniture profile
- shallow mounting hole depth

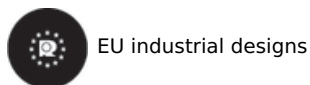

EU industrial designs



CE



Made in Poland



Buy product

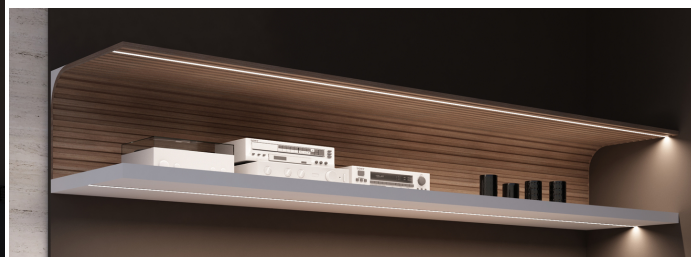
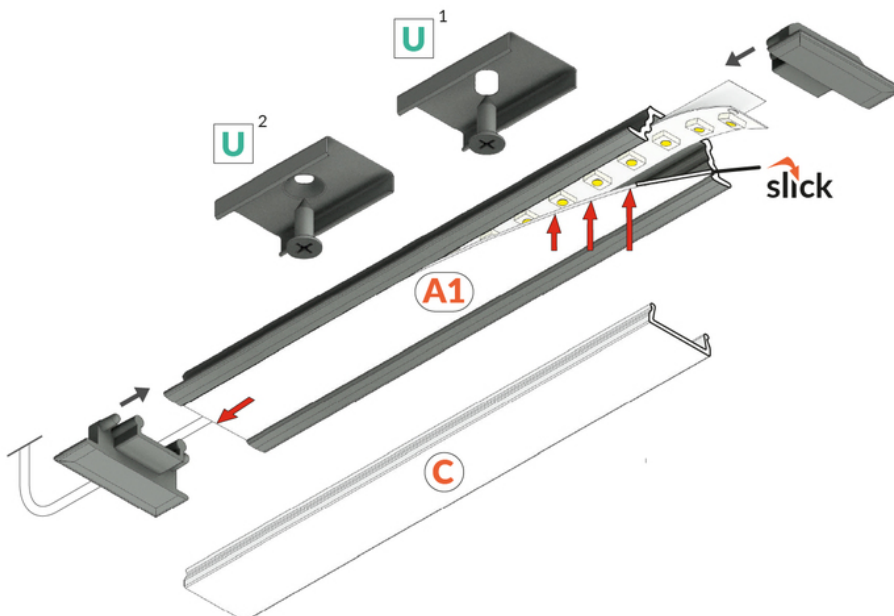
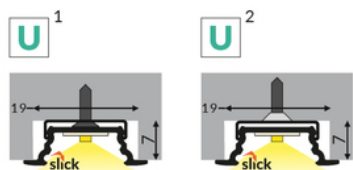
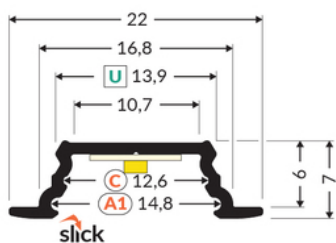

TOPMET LIGHT KŁOSOWICZ WIŚNIEWSKI sp. z o.o.

Ostrowska 354 | 61-312 Poznań | POLAND

tel.: +48 61 872 75 00

info@topmet.pl

pdf card generation date: 27.06.2026



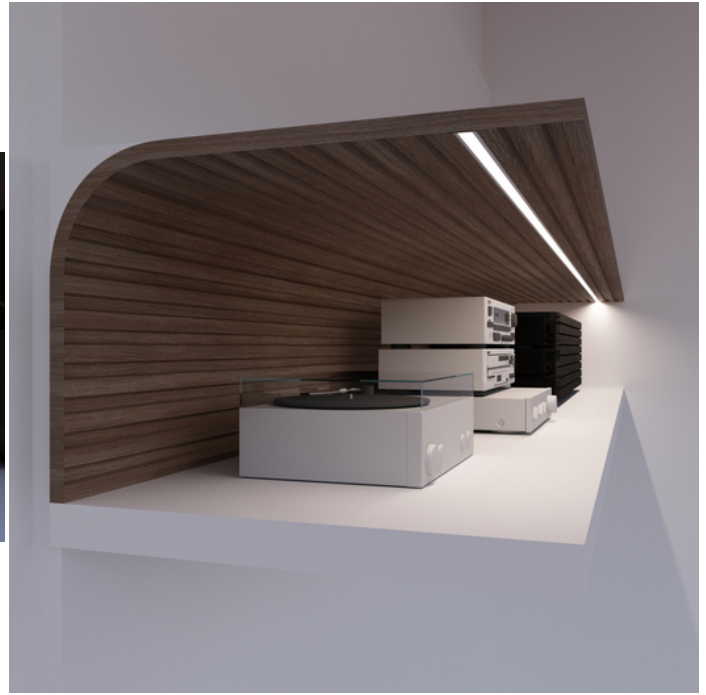



Basic Informations

EAN: 5901597231738 Index: K5000401 Material: aluminium Color: white painted Length [mm]: 4050 Weight [kg]: 0.446 Net weight [kg]: 0.012 Country of origin: PL	Measurement unit: qty Product packaging dimensions [mm]: 4050 x 22 x 7 Bulk packing [qty]: 10 Master packaging type: Bulk Product with gross packaging weight [kg]: 4.46
--	--

AVAILABLE COLORS





 <p>LED profile GROOVE10.v2 A1C/U 4050 raw alu. K5000400</p>	 <p>LED profile GROOVE10.v2 A1C/U 4050 anod. K5000420</p>	 <p>LED profile GROOVE10.v2 A1C/U 4050 black anod. /plastic bag K5000421</p>
---	--	---

AVAILABLE VARIANTS

2000 mm, 4050 mm, 1000 mm, 3000 mm

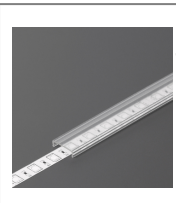
Matching elements

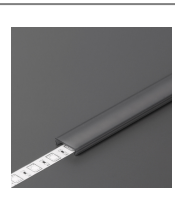
DIFFUSERS

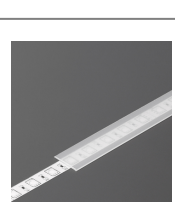
 <p>diffuser C click 4100 transparent index: 76660000</p>	 <p>diffuser C click 4100 opal index: 76660038</p>	 <p>diffuser C click 4100 black index: 76660041</p>
 <p>diffuser C click 20m reel opal /pack index: 76360038S</p>	 <p>diffuser A1 slide 2000 opal index: J6000938</p>	 <p>diffuser A1 slide 2000 frosted index: J6000939</p>

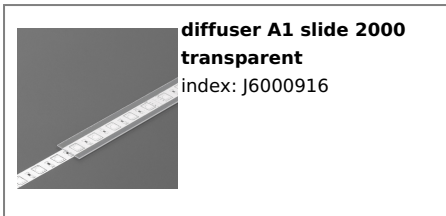

MOUNTINGS

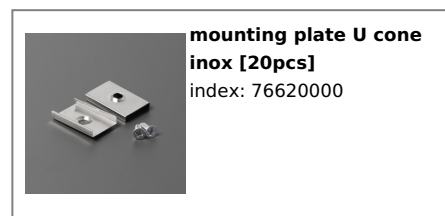

END CAPS

