

LED PROFILE SLIM8 AC2/Z 4050 BLACK ANOD. /PLASTIC BAG

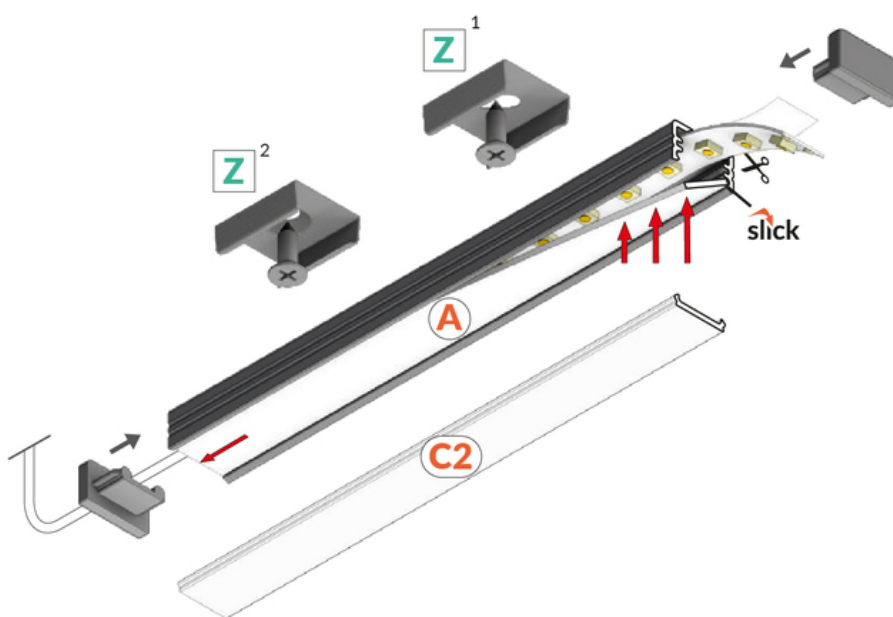

	<ul style="list-style-type: none"> • universal application • Slick socket • painted mounting plates 	EU industrial designs CE Made in Poland	<p>Buy product</p>
--	--	---	--------------------

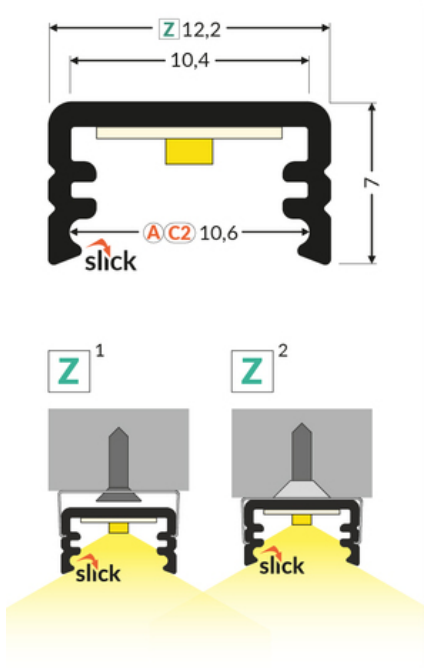

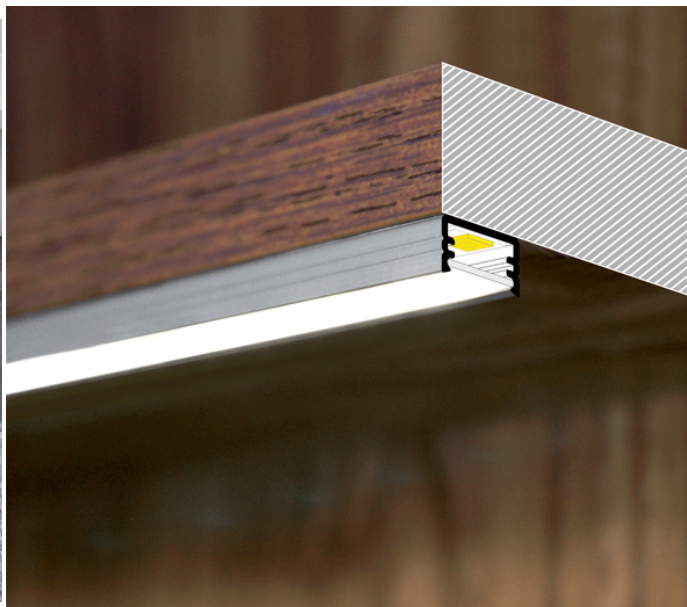

Basic Informations

EAN: 5901597251477
Index: 89200021
Material: aluminium
Color: black anodized
Length [mm]: 4050
Weight [kg]: 0.303
Net weight [kg]: 0.018
Country of origin: PL

Measurement unit: qty
Bulk packing [qty]: 10
Master packaging type: Bulk
Product with gross packaging weight [kg]: 3.03

AVAILABLE COLORS

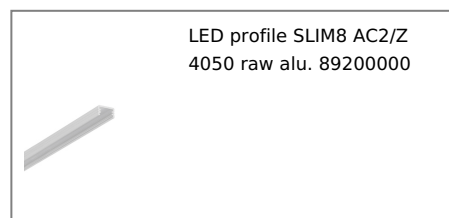
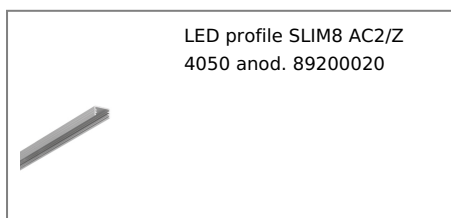

AVAILABLE VARIANTS

1000 mm, 2000 mm, 3000 mm, 4050 mm

Matching elements

TOPMET LIGHT KŁOSOWICZ WIŚNIEWSKI sp. z o.o.

Ostrowska 354 | 61-312 Poznań | POLAND

tel.: +48 61 872 75 00

info@topmet.pl

pdf card generation date: 30.06.2026

DIFFUSERS

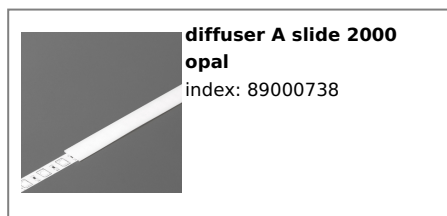
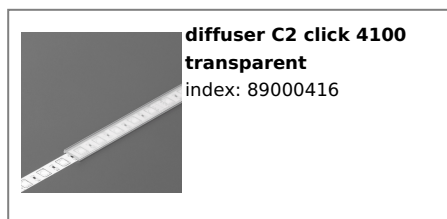
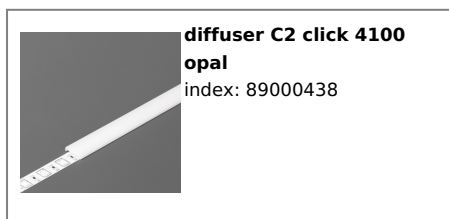

END CAPS



CONNECTORS



MOUNTING PLATES



**mounting plate Z cone
black [20pcs]**

index: 89980002



**mounting plate Z black
[20pcs]**

index: 89270002