

# LED PROFILE SLIM8 AC2/Z 4050 ANOD.







Furniture



max 8 mm



Surface

|   |  |   |  |
|---|--|---|--|
|  | <ul style="list-style-type: none"> <li>• universal application</li> <li>• Slick socket</li> <li>• painted mounting plates</li> </ul> |  EU industrial designs<br> CE<br> Made in Poland | <br>Buy product |
|---|--|---|--|

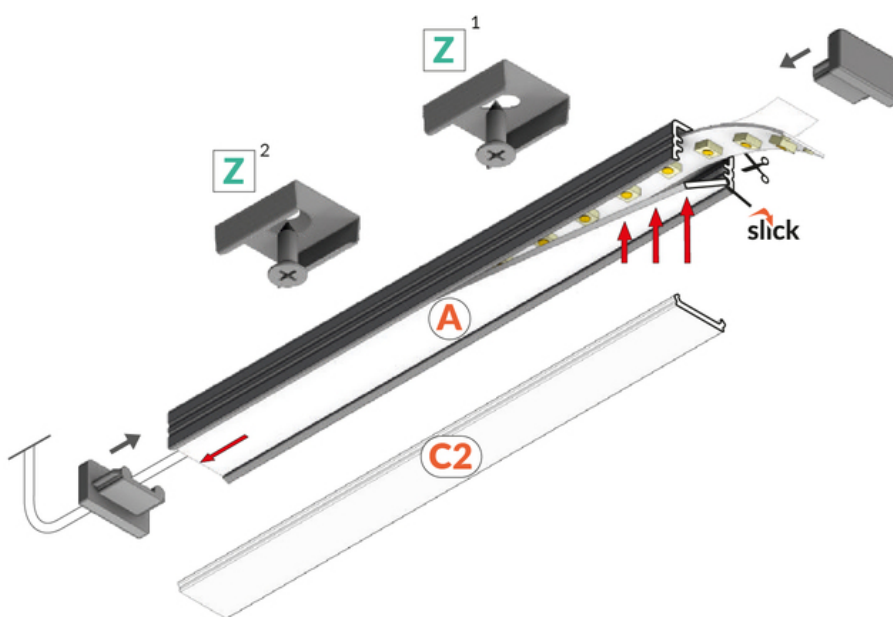
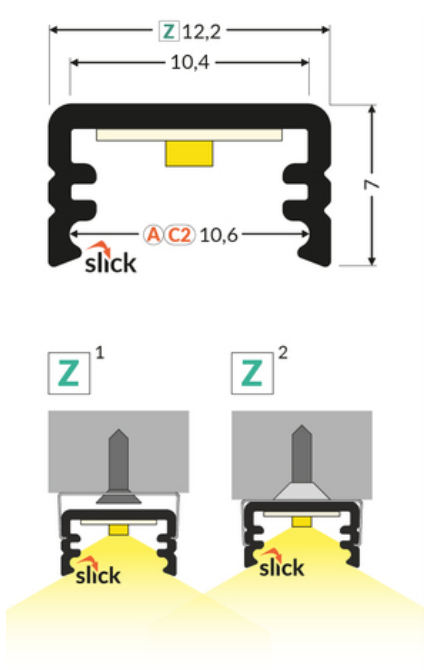

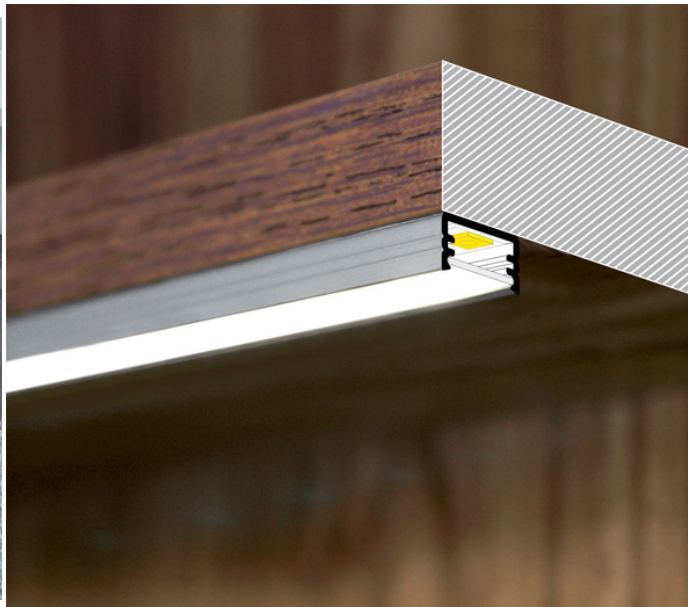

## Basic Informations

EAN: 5901597251446  
Index: 89200020  
Material: aluminium  
Color: anodized  
Length [mm]: 4050  
Weight [kg]: 0.279  
Net weight [kg]: 0.012  
Country of origin: TR

Measurement unit: qty  
Bulk packing [qty]: 40  
Master packaging type: Bulk  
Product with gross packaging weight [kg]: 11.16

## AVAILABLE COLORS

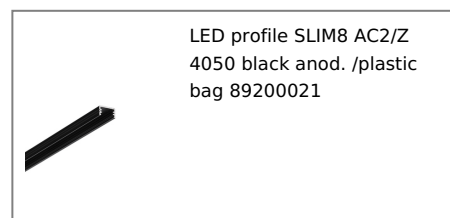
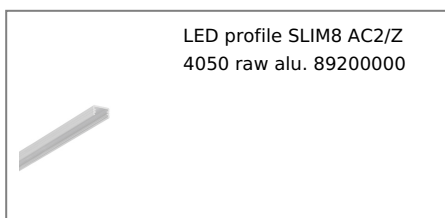

## AVAILABLE VARIANTS

1000 mm, 2000 mm, 3000 mm, 4050 mm

## Matching elements

**TOPMET LIGHT KŁOSOWICZ WIŚNIEWSKI sp. z o.o.**  
Ostrowska 354 | 61-312 Poznań | POLAND  
tel.: +48 61 872 75 00  
info@topmet.pl

pdf card generation date: 30.06.2026



## DIFFUSERS

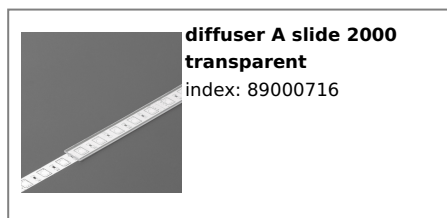
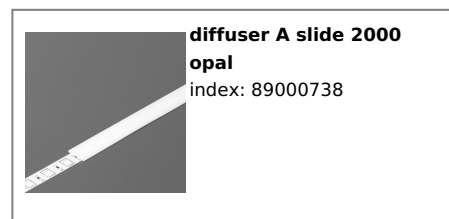
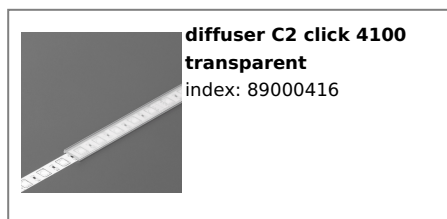
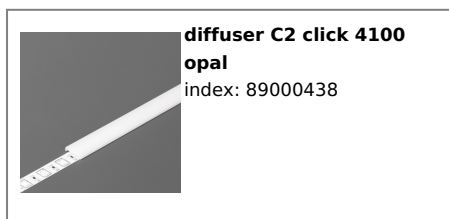

## MOUNTINGS



## END CAPS

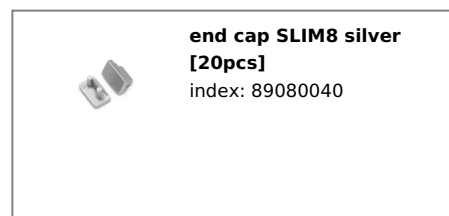
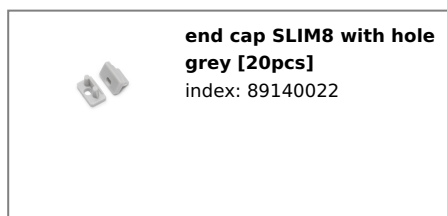
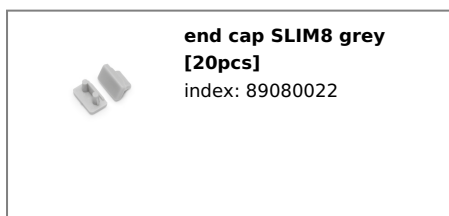



**end cap SLIM8 with hole  
silver [20pcs]**  
index: 89140040



**end cap SLIM8 grey  
[500pcs]**  
index: 89080022W



**end cap SLIM8 silver  
[500pcs]**  
index: 89080040W



**end cap SLIM8 with hole  
grey [500pcs]**  
index: 89140022W

---

## CONNECTORS



**connector SLIM8 90deg  
anod. /plastic bag**  
index: 89150020