

# LED PROFILE SLIM8 AC2/Z 3000 ANOD.







Surface



Furniture



max 8 mm

	<ul style="list-style-type: none"> <li>• universal application</li> <li>• Slick socket</li> <li>• painted mounting plates</li> </ul>	 CE  EU industrial designs  Made in Poland	 Buy product
---	--	---	--

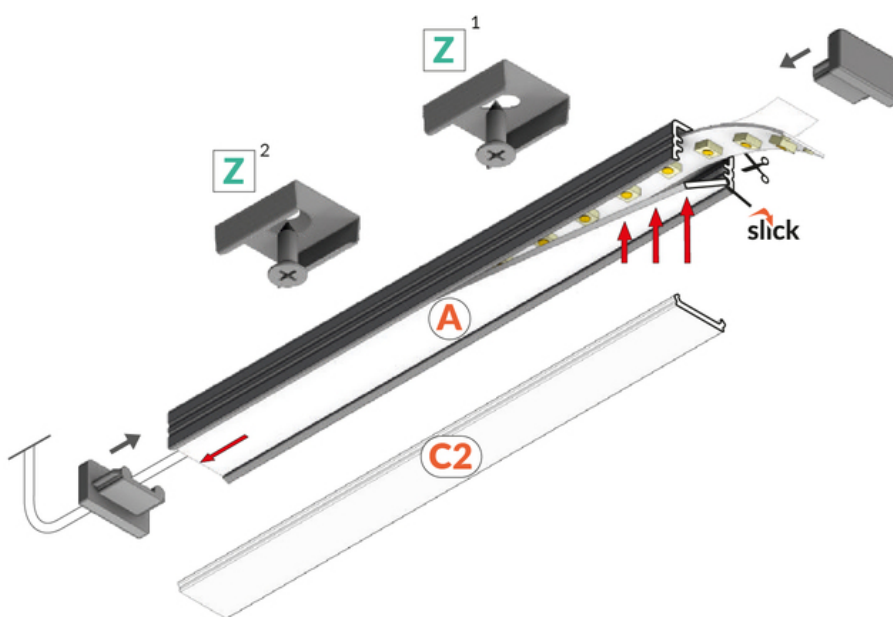
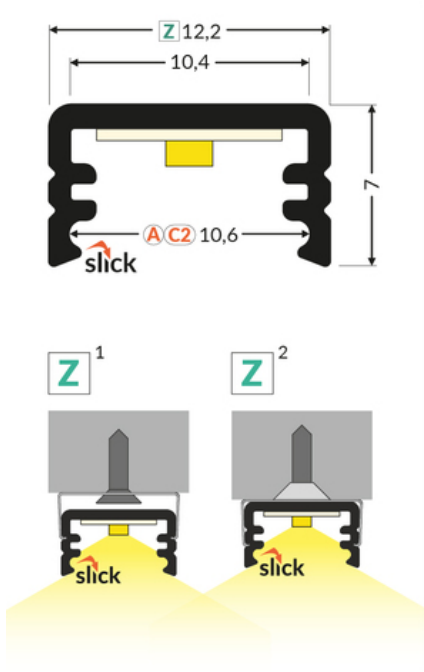

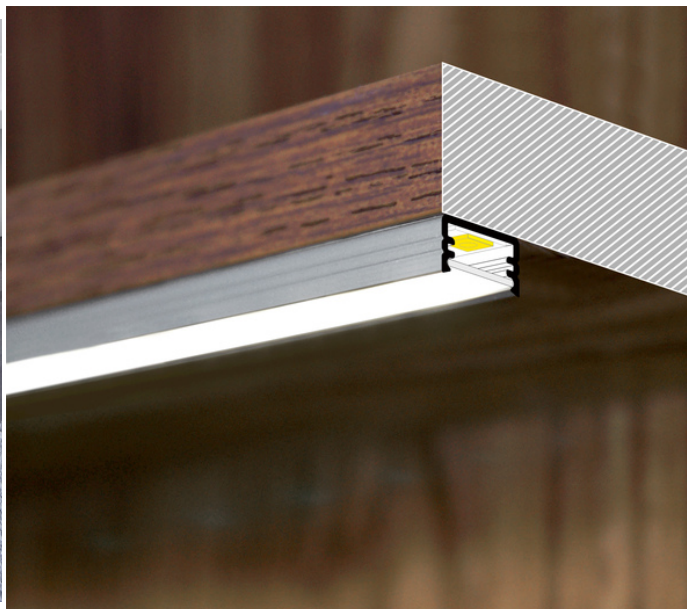

## Basic Informations

EAN: 5901597251378  
Index: 89190020  
Material: aluminium  
Color: anodized  
Length [mm]: 3000  
Weight [kg]: 0.207  
Net weight [kg]: 0.024  
Country of origin: TR

Measurement unit: qty  
Bulk packing [qty]: 40  
Master packaging type: Bulk  
Product with gross packaging weight [kg]: 8.28

## AVAILABLE COLORS

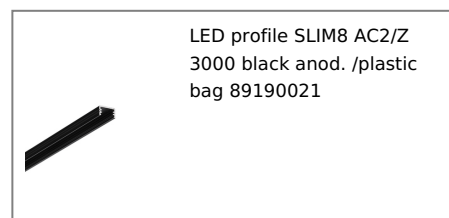
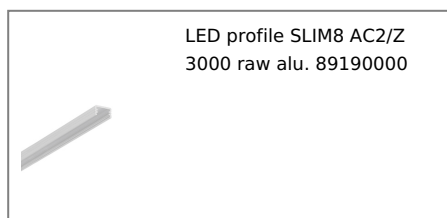

## AVAILABLE VARIANTS

1000 mm, 2000 mm, 3000 mm, 4050 mm

## Matching elements

**TOPMET LIGHT KŁOSOWICZ WIŚNIEWSKI sp. z o.o.**  
Ostrowska 354 | 61-312 Poznań | POLAND  
tel.: +48 61 872 75 00  
info@topmet.pl

pdf card generation date: 30.06.2026



## DIFFUSERS

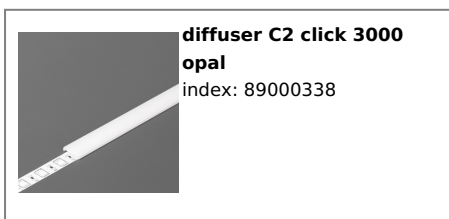

## MOUNTINGS



## END CAPS

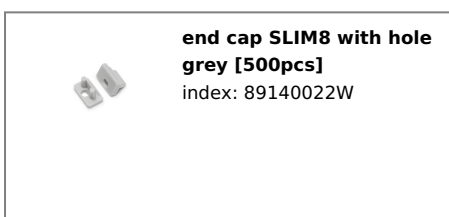
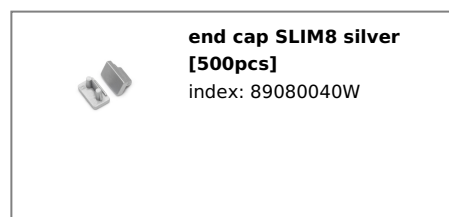
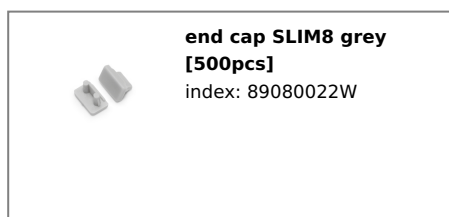
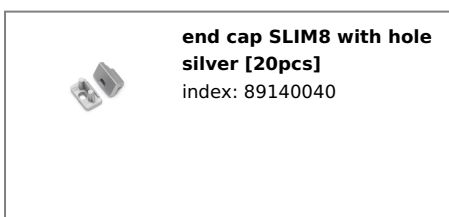
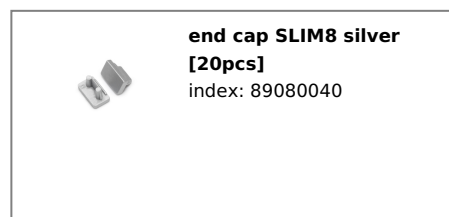
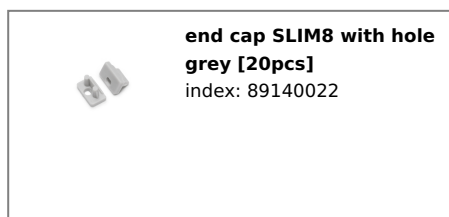
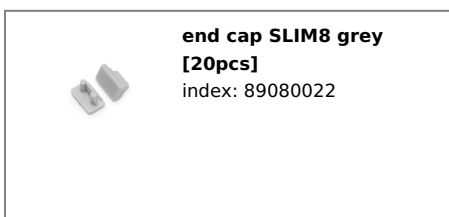

TOPMET LIGHT KŁOSOWICZ WIŚNIEWSKI sp. z o.o.

Ostrowska 354 | 61-312 Poznań | POLAND

tel.: +48 61 872 75 00

info@topmet.pl

pdf card generation date: 30.06.2026

---

## CONNECTORS

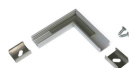

**connector SLIM8 90deg**  
**anod. /plastic bag**  
index: 89150020