

# LED PROFILE SURFACE10 BC/UX 4050 WHITE PAINTED

## RAL9003 /PLASTIC BAG



Surface



Furniture



max 10 mm



- hidden mounting
- wide range of accessories, 7 types of diffusers

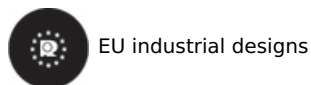

EU industrial designs



CE



Made in Poland



Buy product

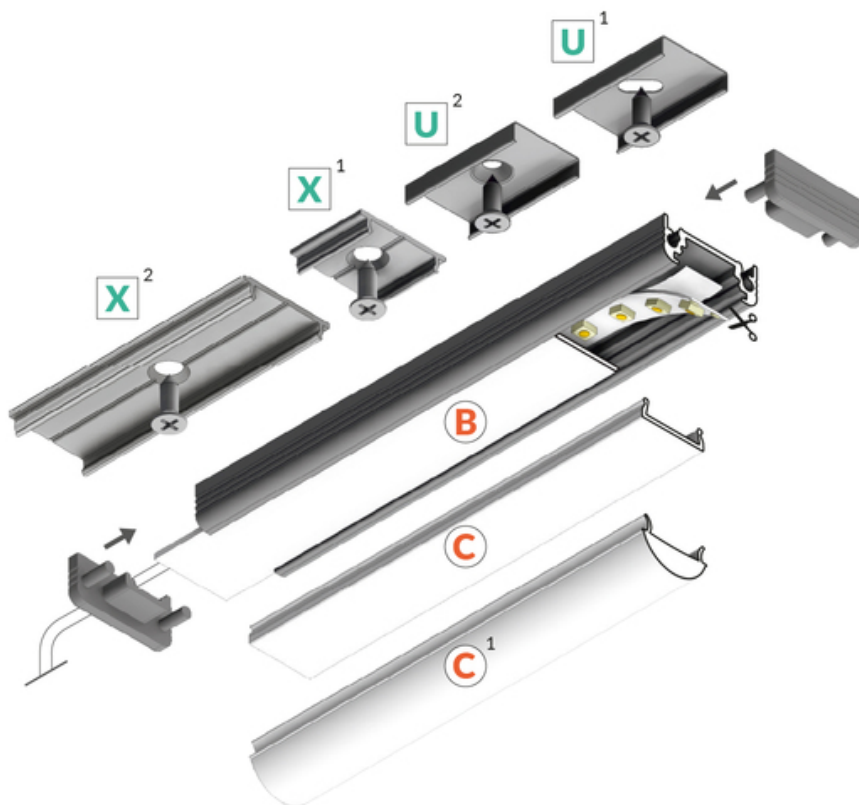
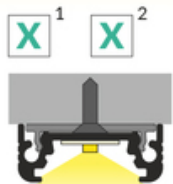
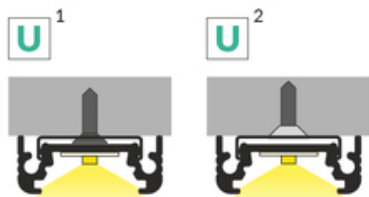
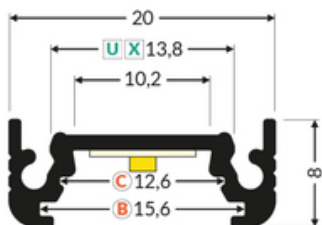

TOPMET LIGHT KŁOSOWICZ WIŚNIEWSKI sp. z o.o.

Ostrowska 354 | 61-312 Poznań | POLAND

tel.: +48 61 872 75 00

info@topmet.pl

pdf card generation date: 29.06.2026



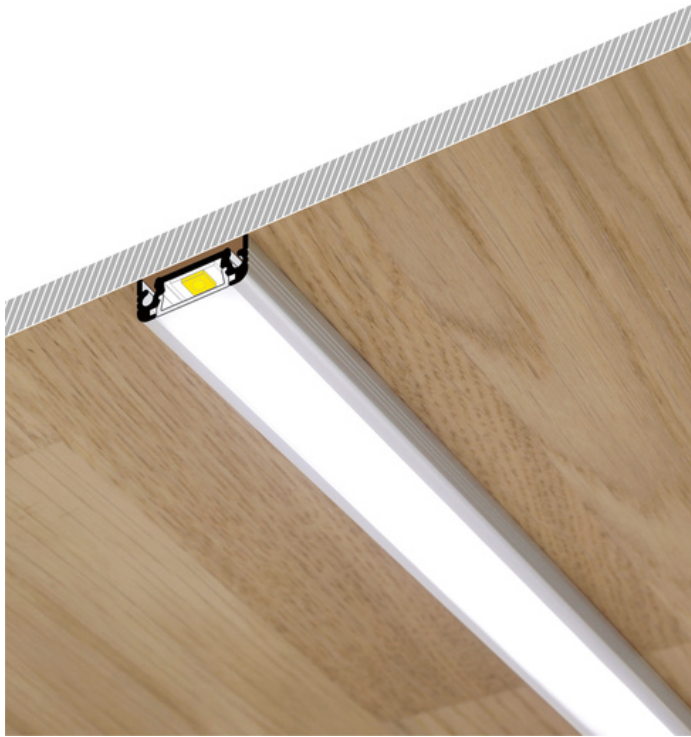

## Basic Informations

<p>EAN: 5901597252115          Index: 77580001          Material: aluminium          Color: white painted          Length [mm]: 4050          Weight [kg]: 0.577          Net weight [kg]: 0.018          Country of origin: PL</p>	<p>Measurement unit: qty          Product packaging dimensions [mm]: 4050 x 20 x 8          Bulk packing [qty]: 10          Master packaging type: Bulk          Product with gross packaging weight [kg]: 5.77</p>
---	---

## AVAILABLE COLORS

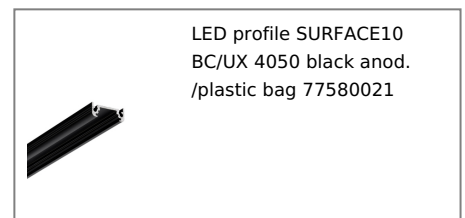
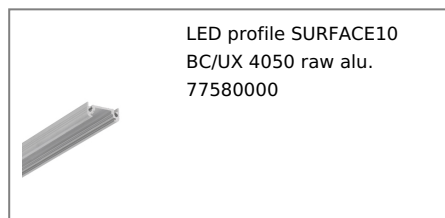
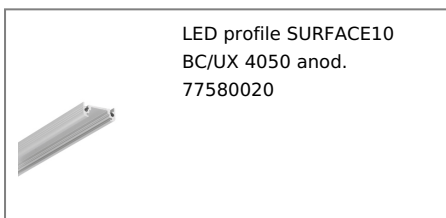

## AVAILABLE VARIANTS

1000 mm, 2000 mm, 3000 mm, 4050 mm

# Matching elements

## DIFFUSERS

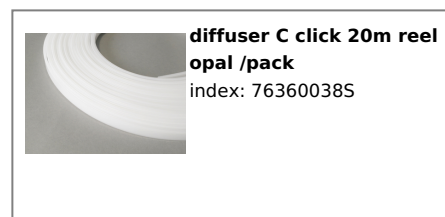

## MOUNTINGS

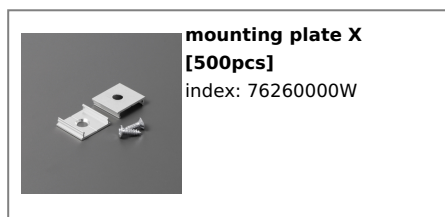

## END CAPS



**(EOL) end cap SURFACE10 white**  
**[20pcs]**  
index: 77280001



**end cap SURFACE10 gen2 white [20pcs]**  
index: 77990001



**end cap SURFACE10 gen2 with hole white [20pcs]**  
index: 77980001

---

## CONNECTORS



**connector SURFACE10 90deg white painted**  
**/plastic bag**  
index: 77410001



**connector X 180deg /plastic bag [1pc]**  
index: 76350000



**connector X 180deg /plastic bag [200pc]**  
index: 76350000W