

LED PROFILE SURFACE10 BC/UX 4050 ANOD.







Furniture



max 10 mm



Surface

	<ul style="list-style-type: none"> • hidden mounting • wide range of accessories, 7 types of diffusers 	 EU industrial designs  CE  Made in Poland	 Buy product
---	--	---	--

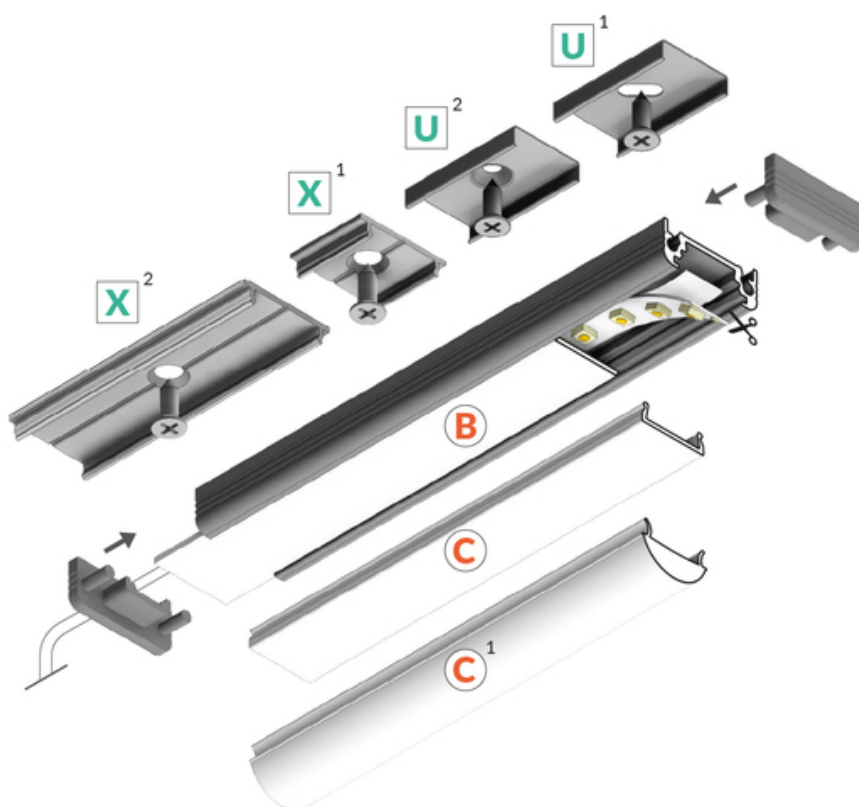
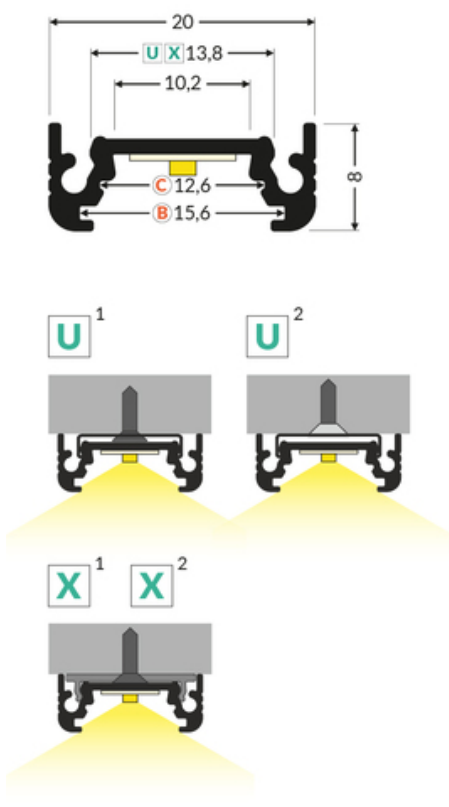

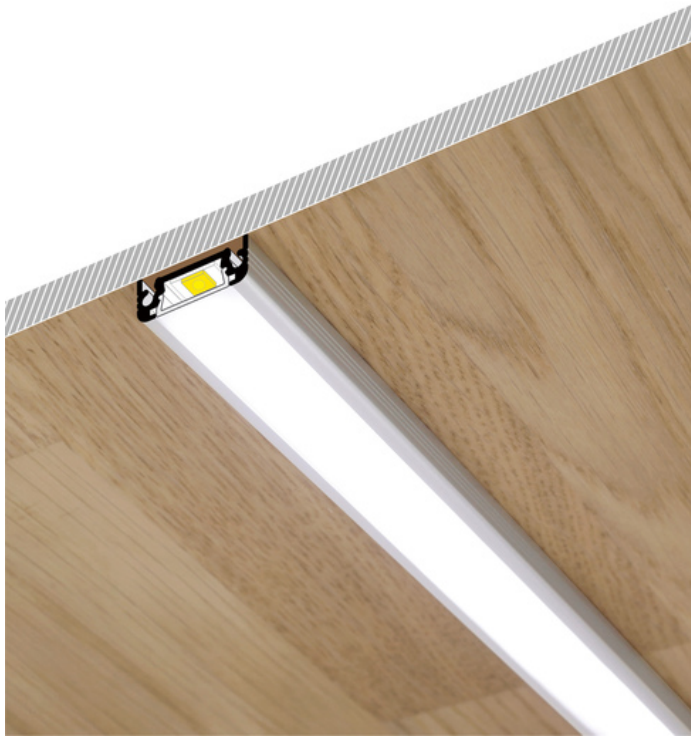

Basic Informations

<p>EAN: 5901597252092 Index: 77580020 Material: aluminium Color: anodized Length [mm]: 4050 Weight [kg]: 0.522 Net weight [kg]: 0.012 Country of origin: PL</p>	<p>Measurement unit: qty Product packaging dimensions [mm]: 4050 x 20 x 8 Bulk packing [qty]: 40 Master packaging type: Bulk Product with gross packaging weight [kg]: 20.88</p>
---	--

AVAILABLE COLORS

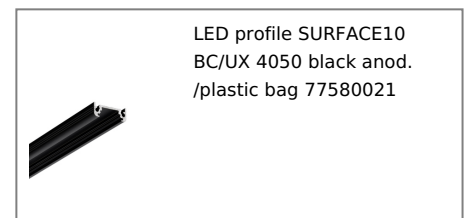
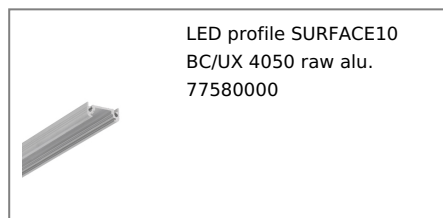
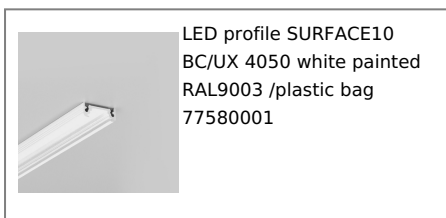

AVAILABLE VARIANTS

1000 mm, 2000 mm, 3000 mm, 4050 mm

Matching elements

DIFFUSERS

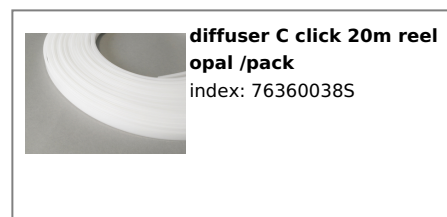

MOUNTINGS

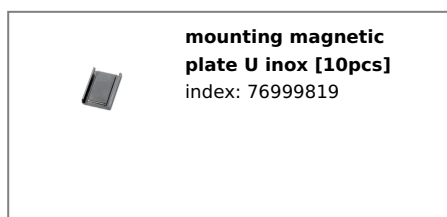
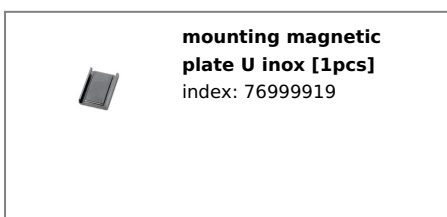
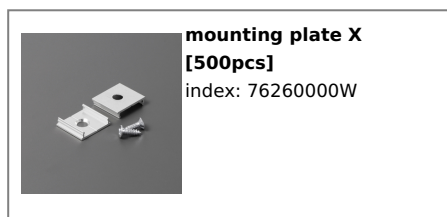

END CAPS

TOPMET LIGHT KŁOSOWICZ WIŚNIEWSKI sp. z o.o.

Ostrowska 354 | 61-312 Poznań | POLAND

tel.: +48 61 872 75 00

info@topmet.pl

pdf card generation date: 30.06.2026



(EOL) end cap SURFACE10 silver
[20pcs]
index: 77280040



end cap SURFACE10 gen2 grey [20pcs]
index: 77990022



end cap SURFACE10 gen2 silver [20pcs]
index: 77990040



end cap SURFACE10 gen2 with hole grey [20pcs]
index: 77980022



end cap SURFACE10 gen2 with hole silver [20pcs]
index: 77980040



end cap SURFACE10 gen2 grey [500pcs]
index: 77990022W



end cap SURFACE10 gen2 with hole grey [500pcs]
index: 77980022W

CONNECTORS



connector SURFACE10 90deg anod. /plastic bag
index: 77410020



connector X 180deg /plastic bag [1pc]
index: 76350000



connector X 180deg /plastic bag [200pc]
index: 76350000W