

# LED PROFILE SURFACE10 BC/UX 3000 BLACK ANOD. /PLASTIC BAG







Surface



Furniture



max 10 mm

	<ul style="list-style-type: none"> <li>• hidden mounting</li> <li>• wide range of accessories, 7 types of diffusers</li> </ul>	 CE  EU industrial designs  Made in Poland	 <p>Buy product</p>
-----------------------------------------------------------------------------------	--------------------------------------------------------------------------------------------------------------------------------	-----------------------------------------------------------------------------------------------------------------------------------------------------------------------------------------------------------------------------------------------------------------------------------------------------	-----------------------------------------------------------------------------------------------------------

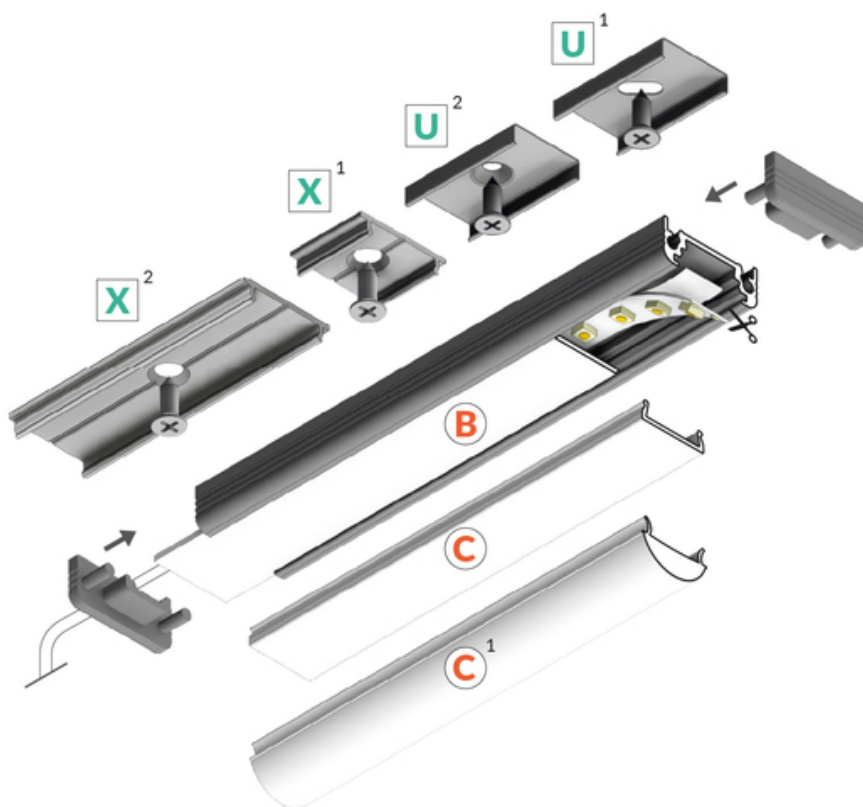
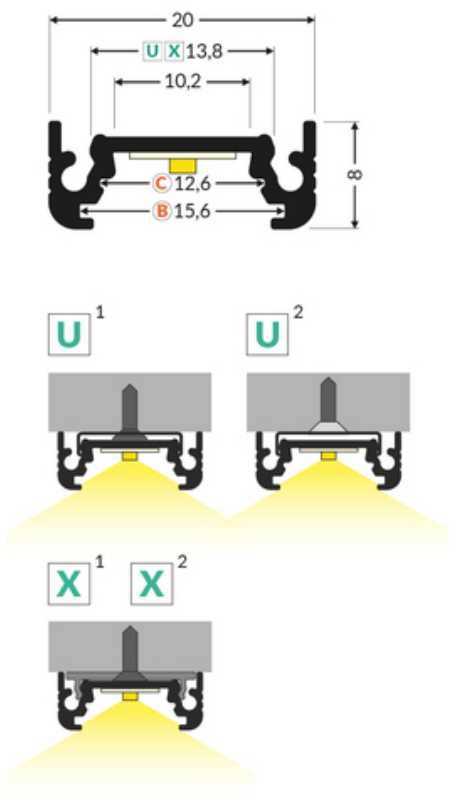

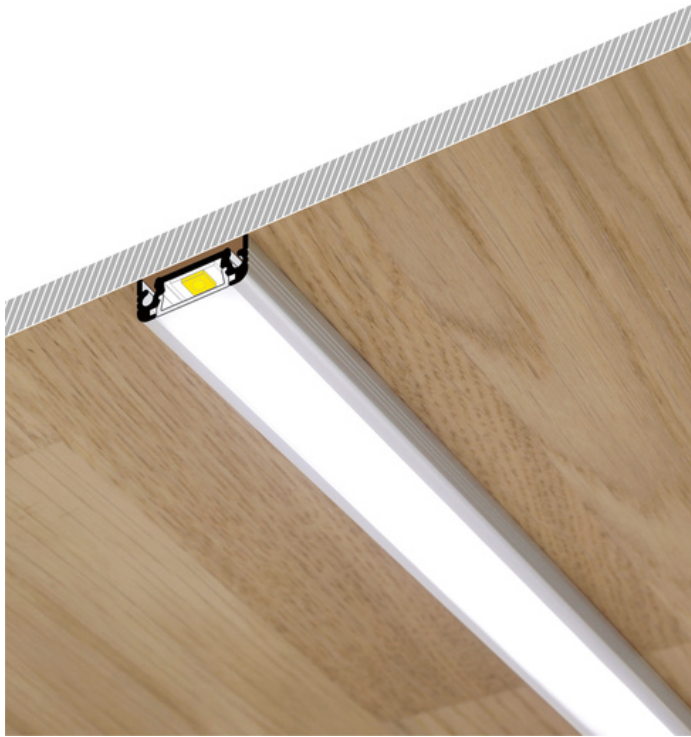

## Basic Informations

EAN: 5901597252061  
Index: 77570021  
Material: aluminium  
Color: black anodized  
Length [mm]: 3000  
Weight [kg]: 0.405  
Net weight [kg]: 0.006  
Country of origin: PL

Measurement unit: qty  
Product packaging dimensions [mm]: 3000 x 20 x 8  
Bulk packing [qty]: 10  
Master packaging type: Bulk  
Product with gross packaging weight [kg]: 4.05

## AVAILABLE COLORS

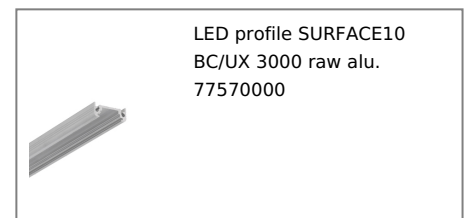
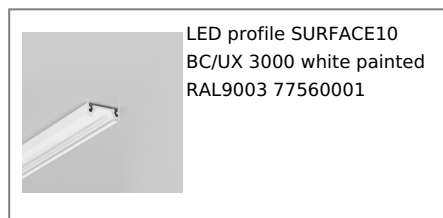
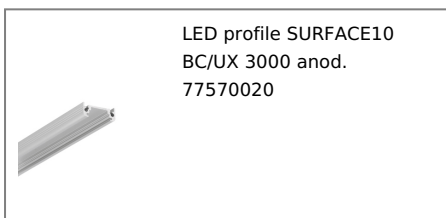

## AVAILABLE VARIANTS

1000 mm, 2000 mm, 3000 mm, 4050 mm

# Matching elements

## DIFFUSERS



## MOUNTINGS

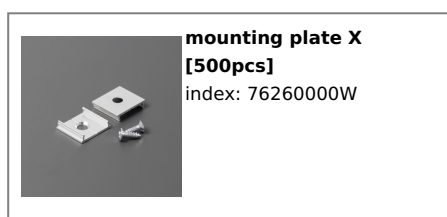

## END CAPS

TOPMET LIGHT KŁOSOWICZ WIŚNIEWSKI sp. z o.o.

Ostrowska 354 | 61-312 Poznań | POLAND

tel.: +48 61 872 75 00

info@topmet.pl

pdf card generation date: 30.06.2026



**end cap SURFACE10  
gen2 black [20pcs]**  
index: 77990002



**end cap SURFACE10  
gen2 with hole black  
[20pcs]**  
index: 77980002

---

## CONNECTORS



**connector SURFACE10  
90deg black anod.  
/plastic bag**  
index: 77410021



**connector X 180deg  
/plastic bag [1pc]**  
index: 76350000



**connector X 180deg  
/plastic bag [200pc]**  
index: 76350000W