

# LED PROFILE SURFACE10 BC/UX 3000 RAW ALU.







Surface



Furniture



max 10 mm

	<ul style="list-style-type: none"> <li>• hidden mounting</li> <li>• wide range of accessories, 7 types of diffusers</li> </ul>	 CE  EU industrial designs  Made in Poland	 <p>Buy product</p>
---	--	---	---

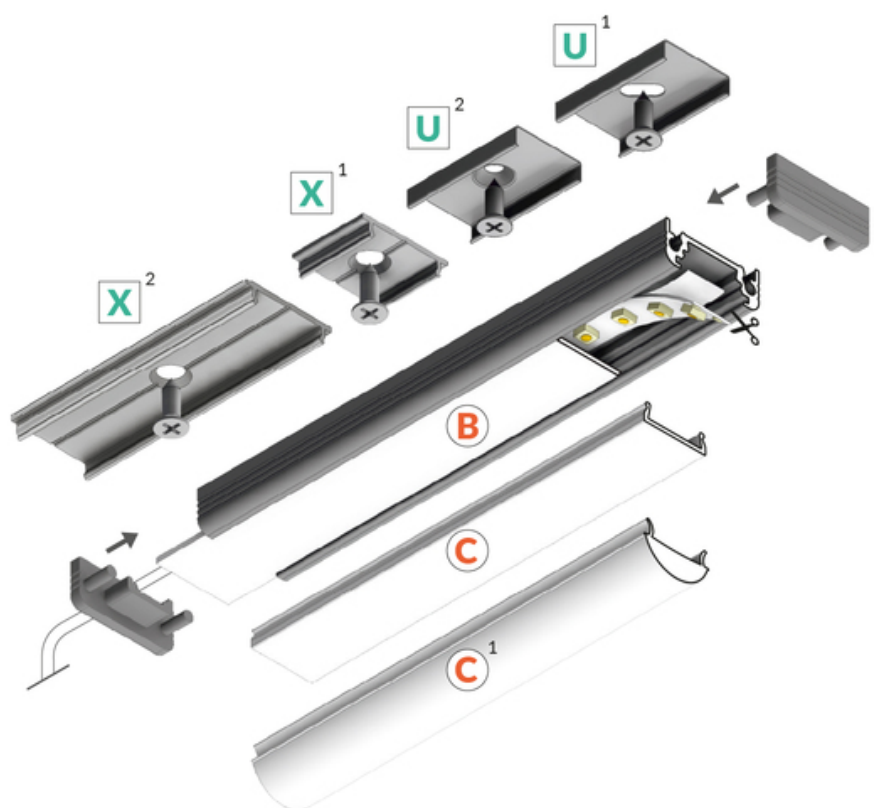
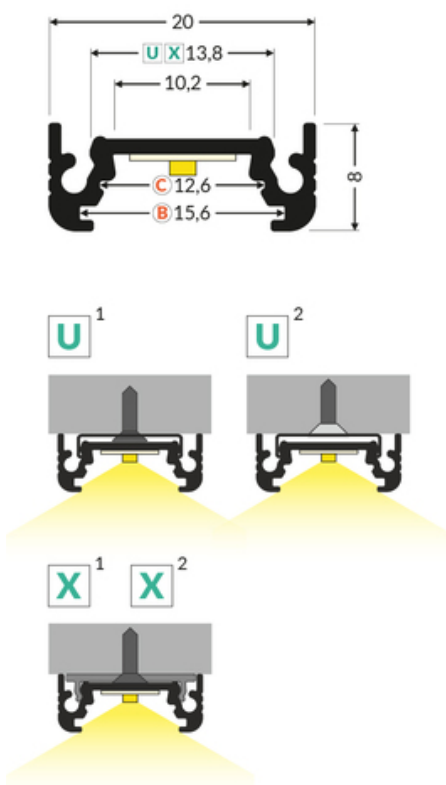

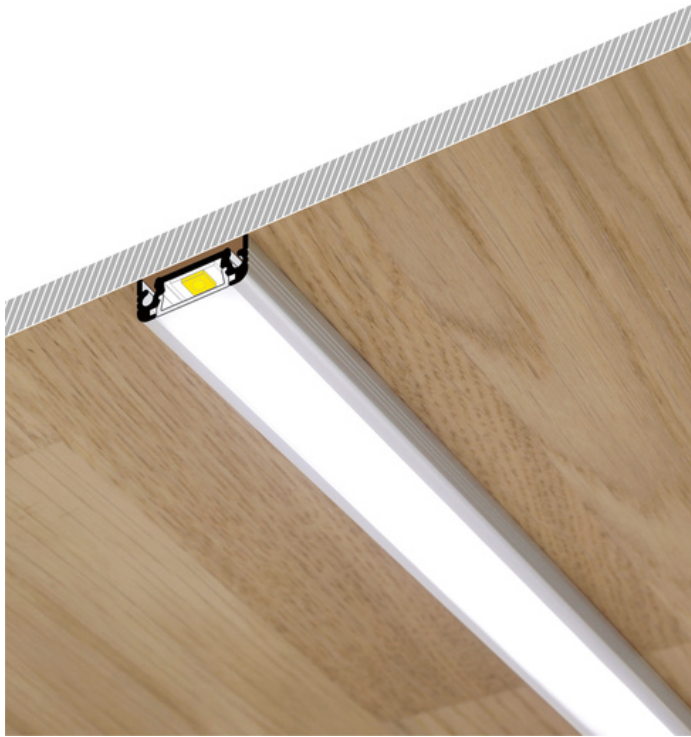

## Basic Informations

<p>EAN: 5901597252016          Index: 77570000          Material: aluminium          Color: raw aluminium          Length [mm]: 3000          Weight [kg]: 0.387          Net weight [kg]: 0.024          Country of origin: PL</p>	<p>Measurement unit: qty          Product packaging dimensions [mm]: 3000 x 20 x 8          Bulk packing [qty]: 40          Master packaging type: Bulk          Product with gross packaging weight [kg]: 15.48</p>
---	--

## AVAILABLE COLORS

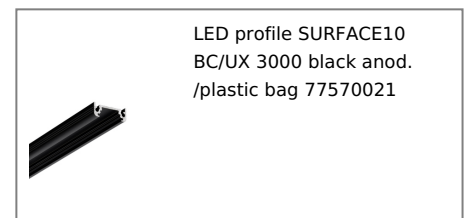
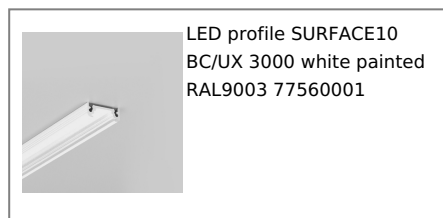
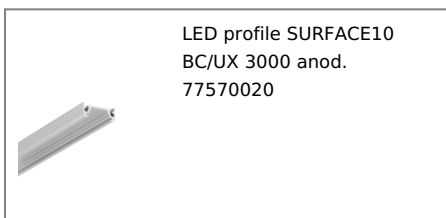

## AVAILABLE VARIANTS

1000 mm, 2000 mm, 3000 mm, 4050 mm

# Matching elements

## DIFFUSERS

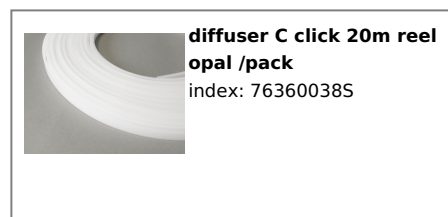

## MOUNTINGS

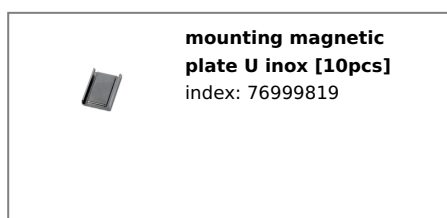
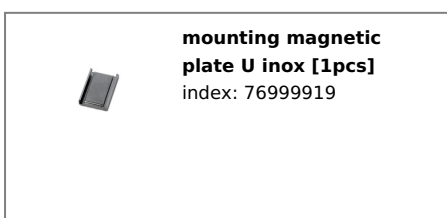
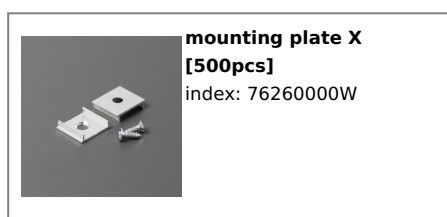

## END CAPS

**TOPMET LIGHT KŁOSOWICZ WIŚNIEWSKI sp. z o.o.**

Ostrowska 354 | 61-312 Poznań | POLAND

tel.: +48 61 872 75 00

info@topmet.pl

pdf card generation date: 29.06.2026





**(EOL) end cap SURFACE10 silver [20pcs]**  
index: 77280040



**end cap SURFACE10 gen2 grey [20pcs]**  
index: 77990022



**end cap SURFACE10 gen2 silver [20pcs]**  
index: 77990040



**end cap SURFACE10 gen2 with hole grey [20pcs]**  
index: 77980022



**end cap SURFACE10 gen2 with hole silver [20pcs]**  
index: 77980040



**end cap SURFACE10 gen2 grey [500pcs]**  
index: 77990022W



**end cap SURFACE10 gen2 with hole grey [500pcs]**  
index: 77980022W

---

## CONNECTORS



**connector X 180deg /plastic bag [200pc]**  
index: 76350000W