

# LED PROFILE SURFACE10 BC/UX 3000 ANOD.







Furniture



max 10 mm



Surface

	<ul style="list-style-type: none"> <li>• hidden mounting</li> <li>• wide range of accessories, 7 types of diffusers</li> </ul>	 EU industrial designs  CE  Made in Poland	 Buy product
---	--	---	--

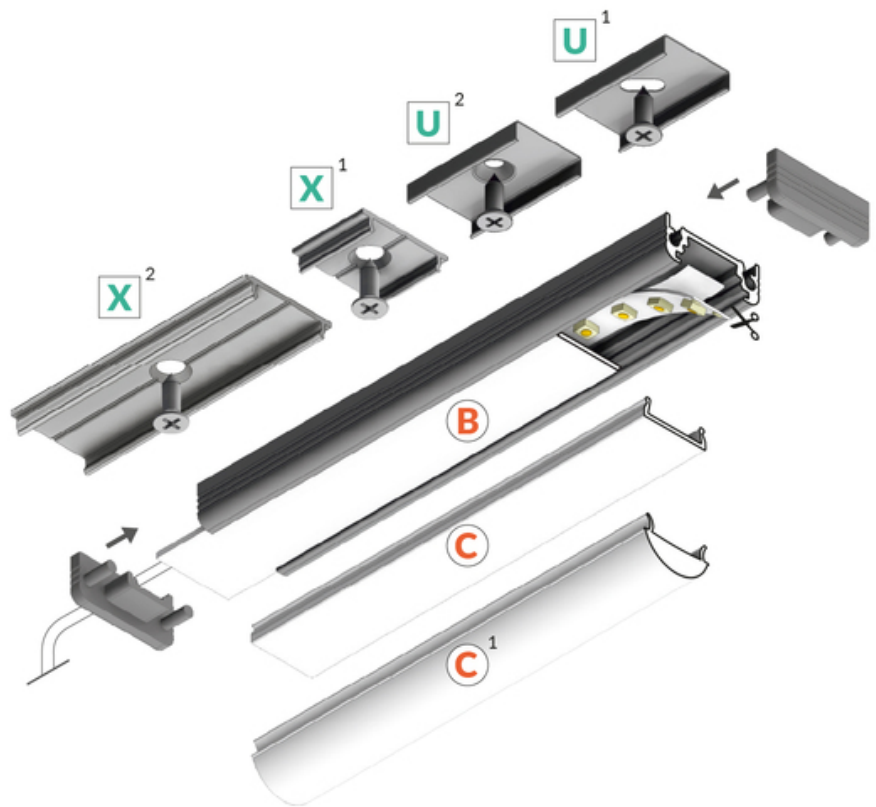
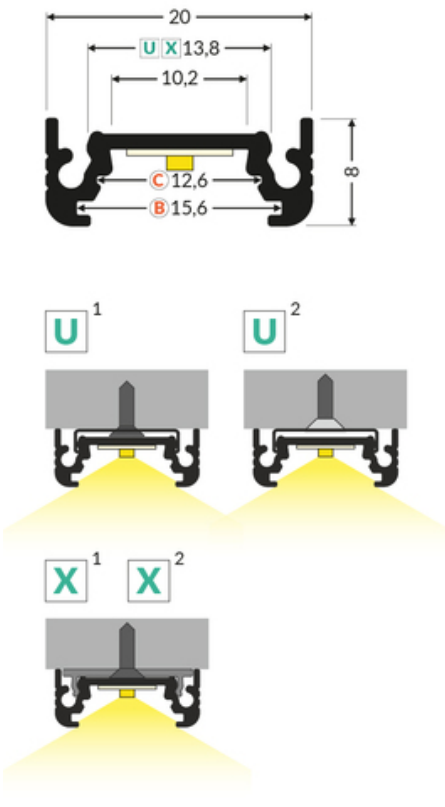

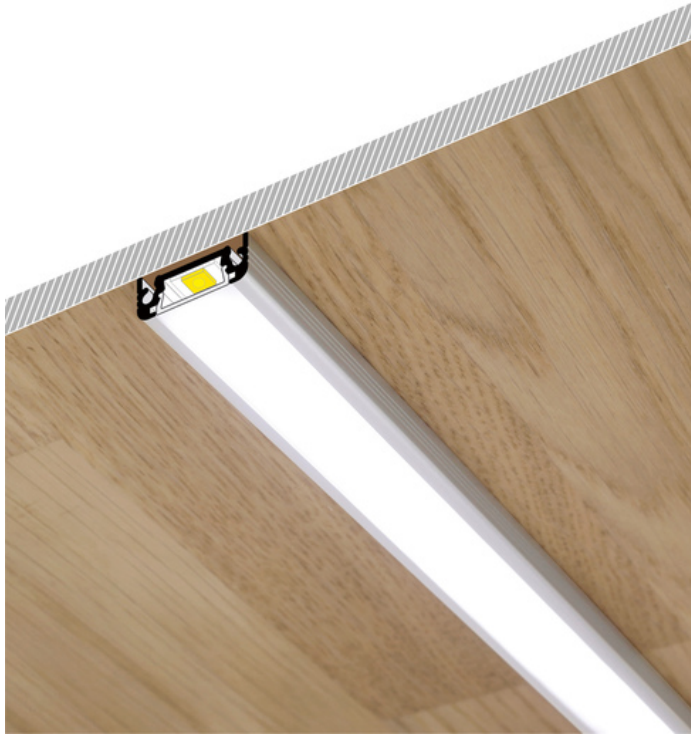

## Basic Informations

<p>EAN: 5901597239222 Index: 77570020 Material: aluminium Color: anodized Length [mm]: 3000 Weight [kg]: 0.387 Net weight [kg]: 0.018 Country of origin: PL</p>	<p>Measurement unit: qty Product packaging dimensions [mm]: 3000 x 20 x 8 Bulk packing [qty]: 40 Master packaging type: Bulk Product with gross packaging weight [kg]: 15.48</p>
---	--

## AVAILABLE COLORS

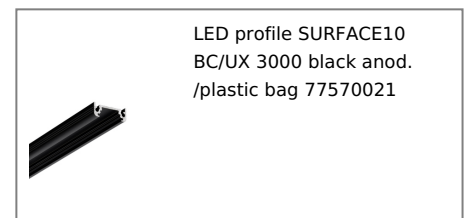
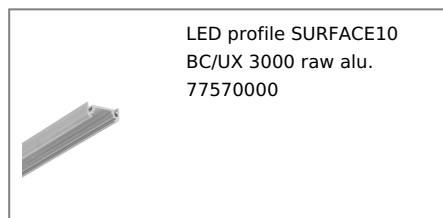
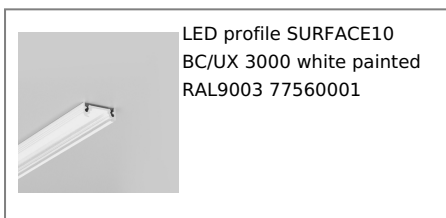

## AVAILABLE VARIANTS

1000 mm, 2000 mm, 3000 mm, 4050 mm

# Matching elements

## DIFFUSERS

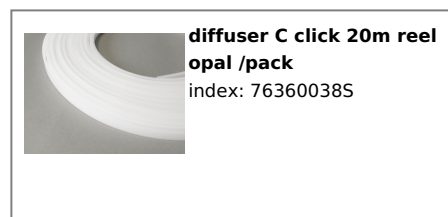

## MOUNTINGS

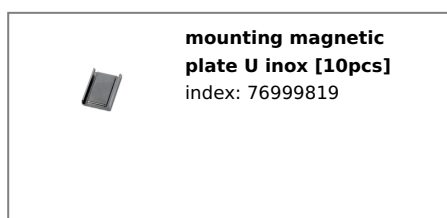
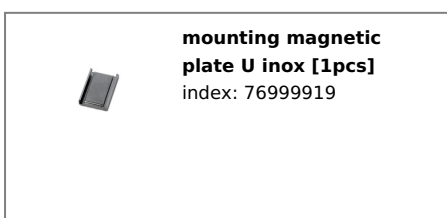
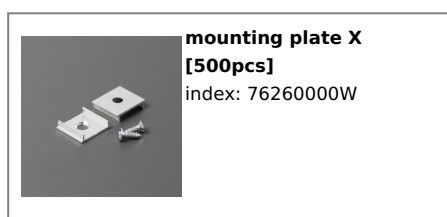

## END CAPS

TOPMET LIGHT KŁOSOWICZ WIŚNIEWSKI sp. z o.o.

Ostrowska 354 | 61-312 Poznań | POLAND

tel.: +48 61 872 75 00

info@topmet.pl

pdf card generation date: 30.06.2026





**(EOL) end cap SURFACE10 silver**  
**[20pcs]**  
index: 77280040



**end cap SURFACE10 gen2 grey [20pcs]**  
index: 77990022



**end cap SURFACE10 gen2 silver [20pcs]**  
index: 77990040



**end cap SURFACE10 gen2 with hole grey [20pcs]**  
index: 77980022



**end cap SURFACE10 gen2 with hole silver [20pcs]**  
index: 77980040



**end cap SURFACE10 gen2 grey [500pcs]**  
index: 77990022W



**end cap SURFACE10 gen2 with hole grey [500pcs]**  
index: 77980022W

---

## CONNECTORS



**connector SURFACE10 90deg anod. /plastic bag**  
index: 77410020



**connector X 180deg /plastic bag [1pc]**  
index: 76350000



**connector X 180deg /plastic bag [200pc]**  
index: 76350000W