

LED PROFILE UNI12 BCD/U 3000 RAW ALU.



Furniture



Surface



Recessed



EU industrial designs



CE



Made in Poland



Buy product

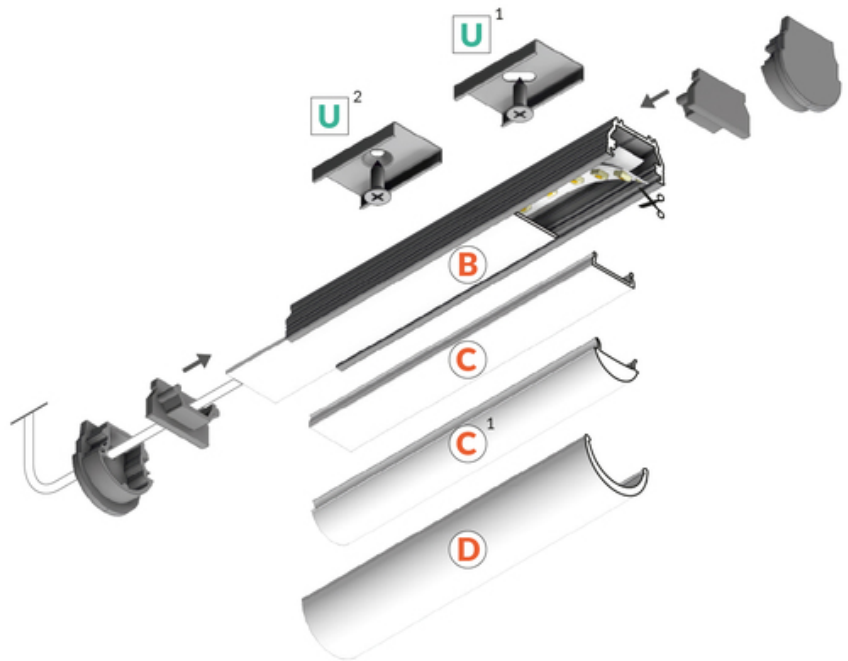
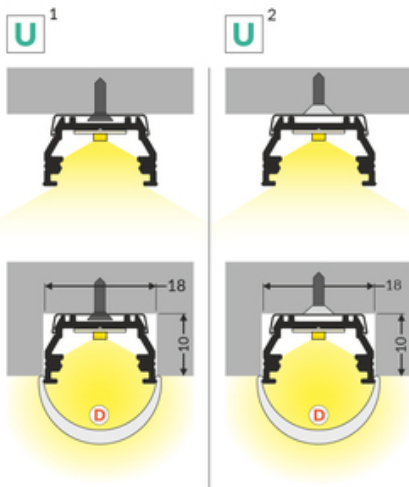
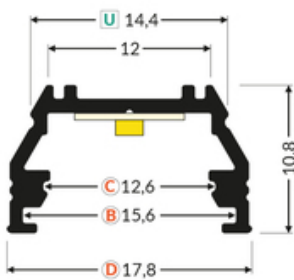

TOPMET LIGHT KŁOSOWICZ WIŚNIEWSKI sp. z o.o.

Ostrowska 354 | 61-312 Poznań | POLAND

tel.: +48 61 872 75 00

info@topmet.pl

pdf card generation date: 27.06.2026



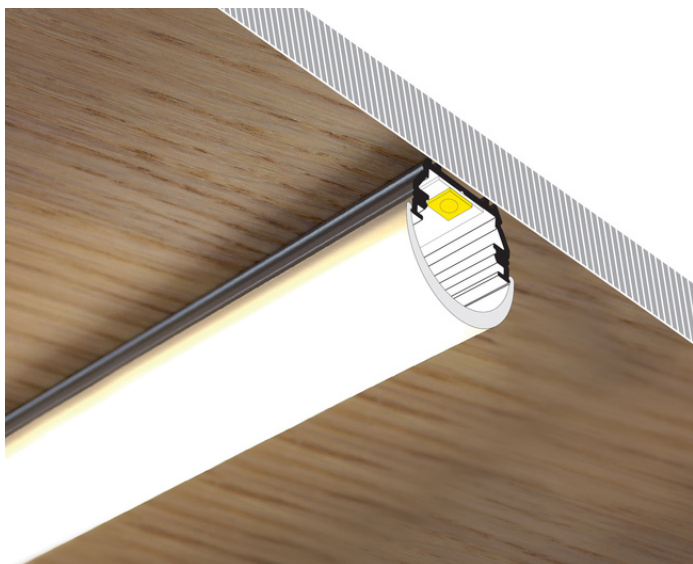

Basic Informations

EAN: 5901597252498
Index: A1170000
Material: aluminium
Color: raw aluminium
Length [mm]: 3000
Weight [kg]: 0.39
Net weight [kg]: 0.015
Country of origin: PL

Measurement unit: qty
Product packaging dimensions [mm]: 3000 x 17,8 x 10,8
Bulk packing [qty]: 40
Master packaging type: Bulk
Product with gross packaging weight [kg]: 15.6

AVAILABLE COLORS

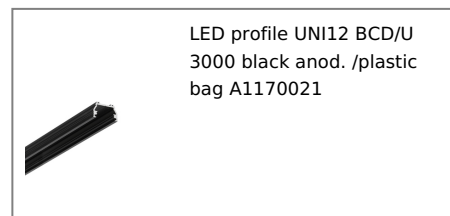
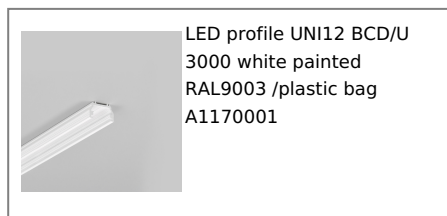
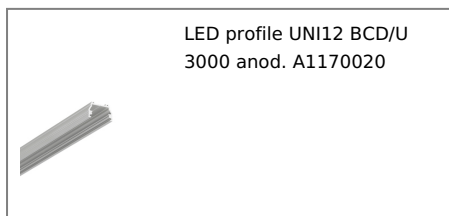

AVAILABLE VARIANTS

1000 mm, 2000 mm, 3000 mm, 4050 mm

Matching elements

DIFFUSERS

TOPMET LIGHT KŁOSOWICZ WIŚNIEWSKI sp. z o.o.
Ostrowska 354 | 61-312 Poznań | POLAND
tel.: +48 61 872 75 00
info@topmet.pl

pdf card generation date: 27.06.2026

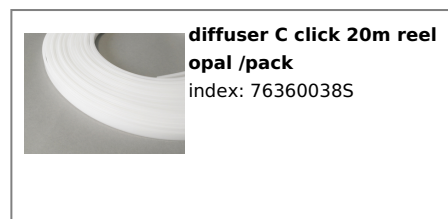
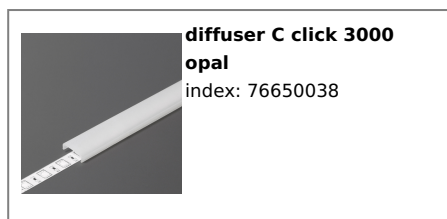

MOUNTINGS

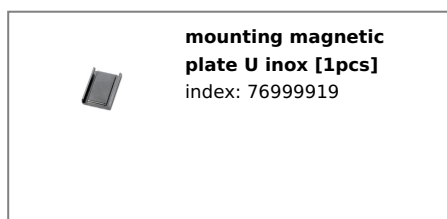
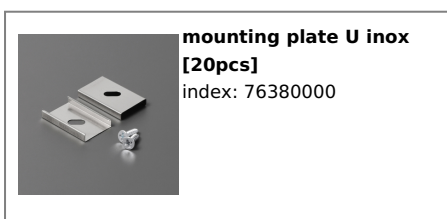

END CAPS

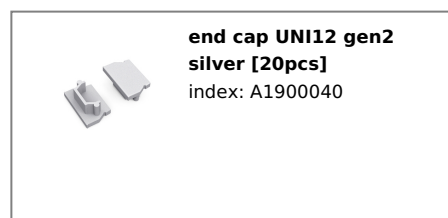
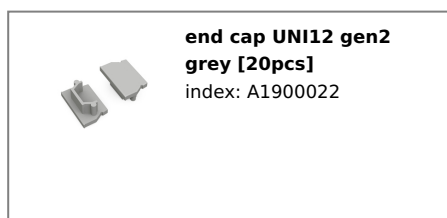
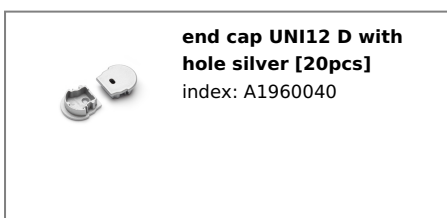
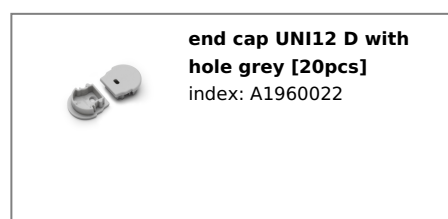
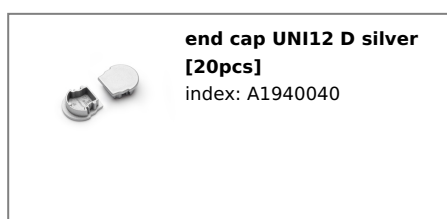
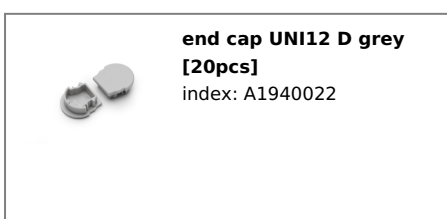



**end cap UNI12 gen2 with
hole grey [20pcs]**
index: A1890022



**end cap UNI12 gen2 with
hole silver [20pcs]**
index: A1890040