

LED PROFILE UNI12 BCD/U 3000 ANOD.



Recessed



Furniture



Surface

	<p> CE</p> <p> EU industrial designs</p> <p> Made in Poland</p>	 <p>Buy product</p>
---	--	--

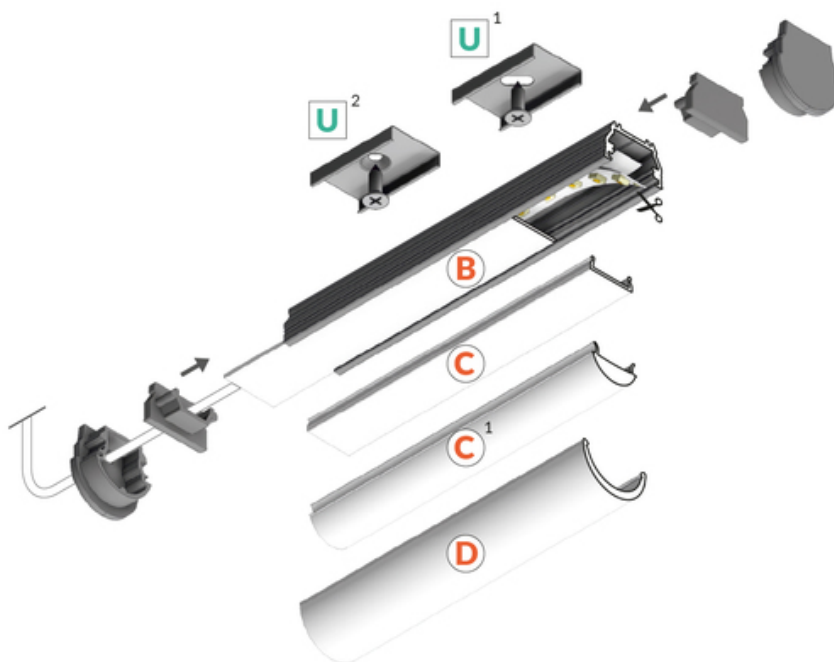
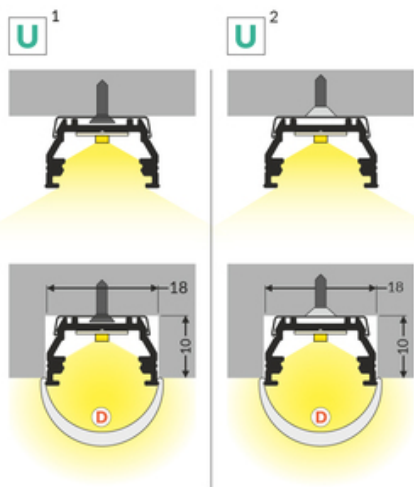
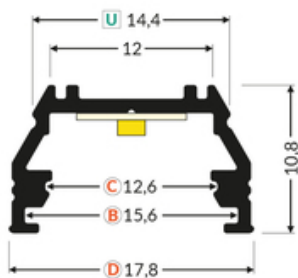

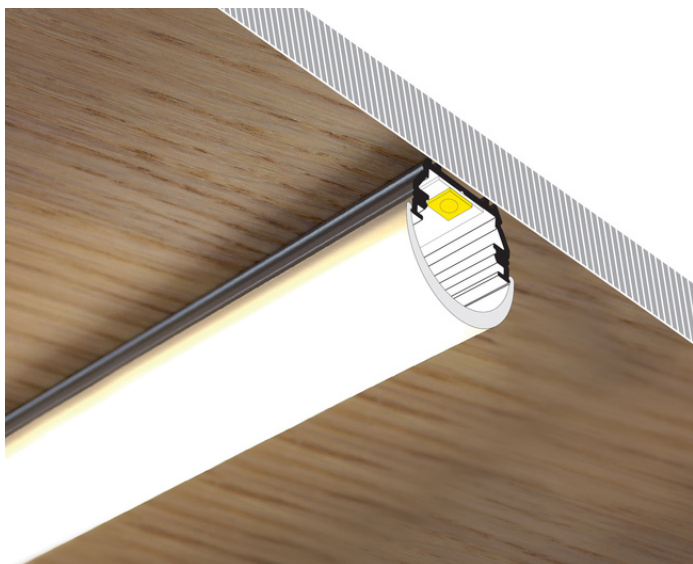

Basic Informations

<p>EAN: 5901597239192 Index: A1170020 Material: aluminium Color: anodized Length [mm]: 3000 Weight [kg]: 0.39 Net weight [kg]: 0.015 Country of origin: PL</p>	<p>Measurement unit: qty Product packaging dimensions [mm]: 3000 x 17,8 x 10,8 Bulk packing [qty]: 40 Master packaging type: Bulk Product with gross packaging weight [kg]: 15.6</p>
---	--

AVAILABLE COLORS

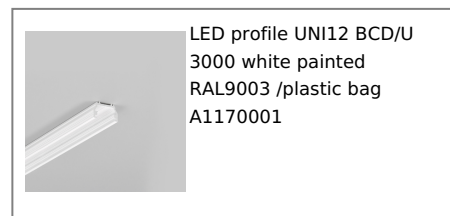
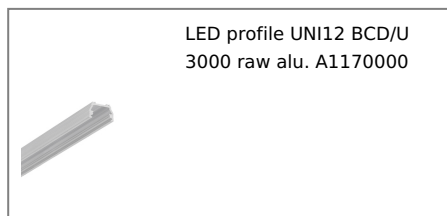
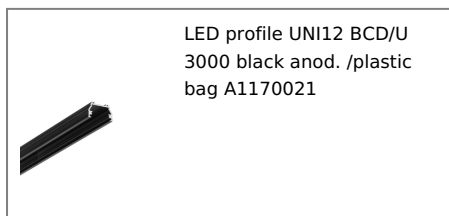

AVAILABLE VARIANTS

1000 mm, 2000 mm, 3000 mm, 4050 mm

Matching elements

DIFFUSERS

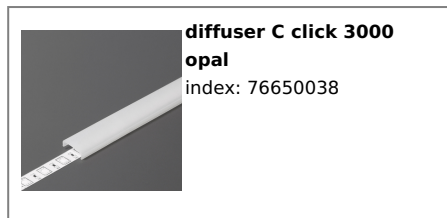

MOUNTINGS

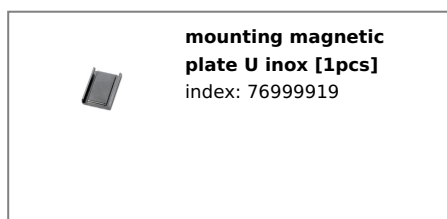
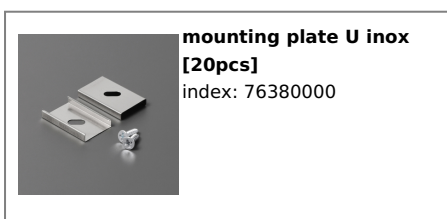

END CAPS

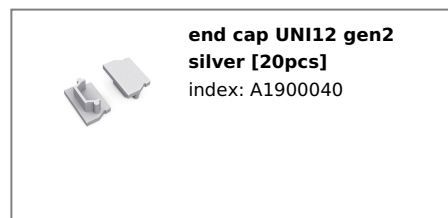
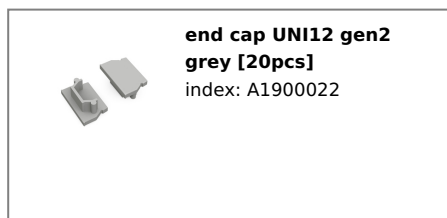
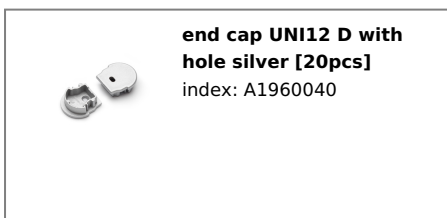
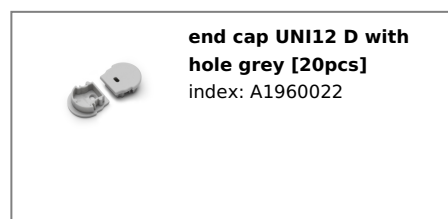
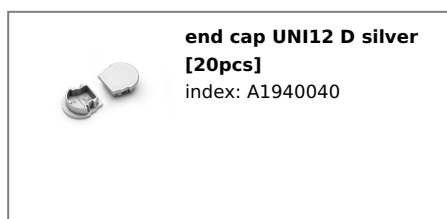
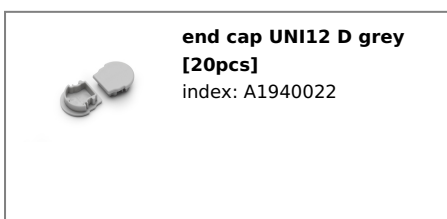

TOPMET LIGHT KŁOSOWICZ WIŚNIEWSKI sp. z o.o.

Ostrowska 354 | 61-312 Poznań | POLAND

tel.: +48 61 872 75 00

info@topmet.pl

pdf card generation date: 29.06.2026



**end cap UNI12 gen2 with
hole grey [20pcs]**
index: A1890022



**end cap UNI12 gen2 with
hole silver [20pcs]**
index: A1890040

CONNECTORS



**connector UNI12 90deg
anod. /plastic bag**
index: A1910020