

LED PROFILE SMART16 BC3/U4 4050 WHITE PAINTED RAL9003 /PLASTIC BAG



Surface



Furniture



max 16 mm

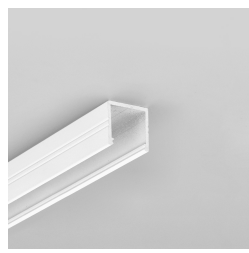

- Slick socket
- easy assembly technology
- 2 channels for mounting bracket (with or without mounting surface distance)
- continuous line of light (when using LED strip 120 P/m and opal diffuser)



EU industrial designs



CE



Made in Poland



Buy product

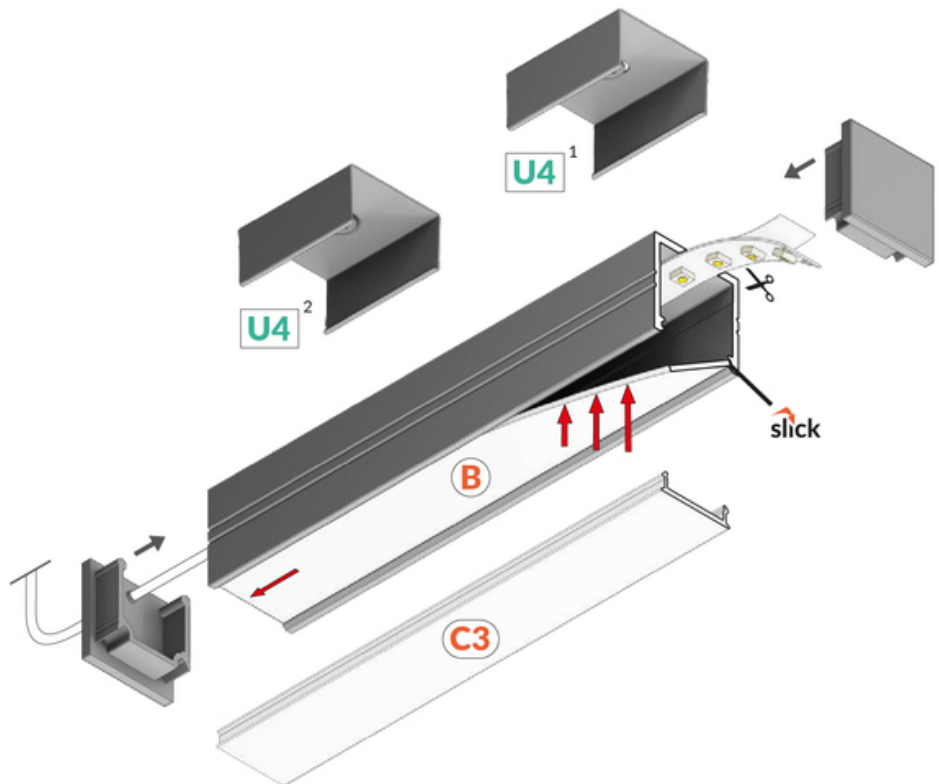
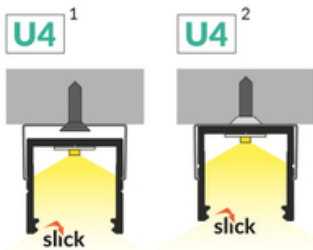
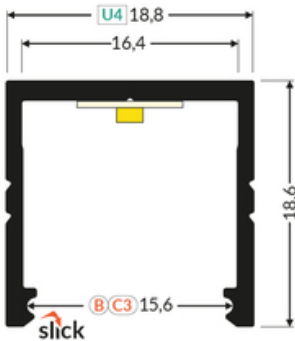

TOPMET LIGHT KŁOSOWICZ WIŚNIEWSKI sp. z o.o.

Ostrowska 354 | 61-312 Poznań | POLAND

tel.: +48 61 872 75 00

info@topmet.pl

pdf card generation date: 30.06.2026







Basic Informations

EAN: 5901597251767 Index: F1040001 Material: aluminium Color: white painted Length [mm]: 4050 Weight [kg]: 0.899 Net weight [kg]: 0.008 Country of origin: PL	Measurement unit: qty Product packaging dimensions [mm]: 4050 x 18,8 x 18,6 Bulk packing [qty]: 10 Master packaging type: Bulk Product with gross packaging weight [kg]: 8.99
--	---

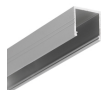
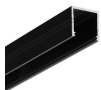
AVAILABLE COLORS





 <p>LED profile SMART16 BC3/U4 4050 anod. F1040020</p>	 <p>LED profile SMART16 BC3/U4 4050 black anod /plastic bag F1040021</p>	 <p>LED profile SMART16 BC3/U4 4050 alu.raw F1040000</p>
---	---	---

AVAILABLE VARIANTS

1000 mm, 2000 mm, 3000 mm, 4050 mm

Matching elements

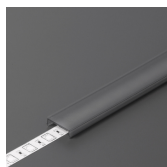
DIFFUSERS

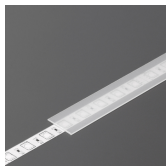
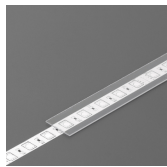
 <p>diffuser C3 click 4100 opal index: F1000438</p>	 <p>diffuser C3 click 4100 transparent index: F1000416</p>	 <p>diffuser C3 click 4100 black /plastic bag index: F1000441</p>
 <p>diffuser B slide 2000 opal index: 76000238</p>	 <p>diffuser B slide 2000 frosted index: 76000239</p>	 <p>diffuser B slide 2000 transparent index: 76000216</p>

END CAPS



**end cap SMART16-BC3
white [20pcs]**
index: F1999901

MOUNTING PLATES



**mounting plate U4 white
painted [20pcs]**
index: F1970001



**mounting plate U4 cone
white painted [20pcs]**
index: F1980001