

LED PROFILE SMART16 BC3/U4 3000 BLACK ANOD /PLASTIC

BAG



Surface



Furniture



max 16 mm

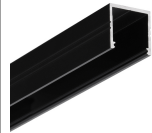

- Slick socket
- easy assembly technology
- 2 channels for mounting bracket (with or without mounting surface distance)
- continuous line of light (when using LED strip 120 P/m and opal diffuser)



EU industrial designs



CE



Made in Poland



Buy product

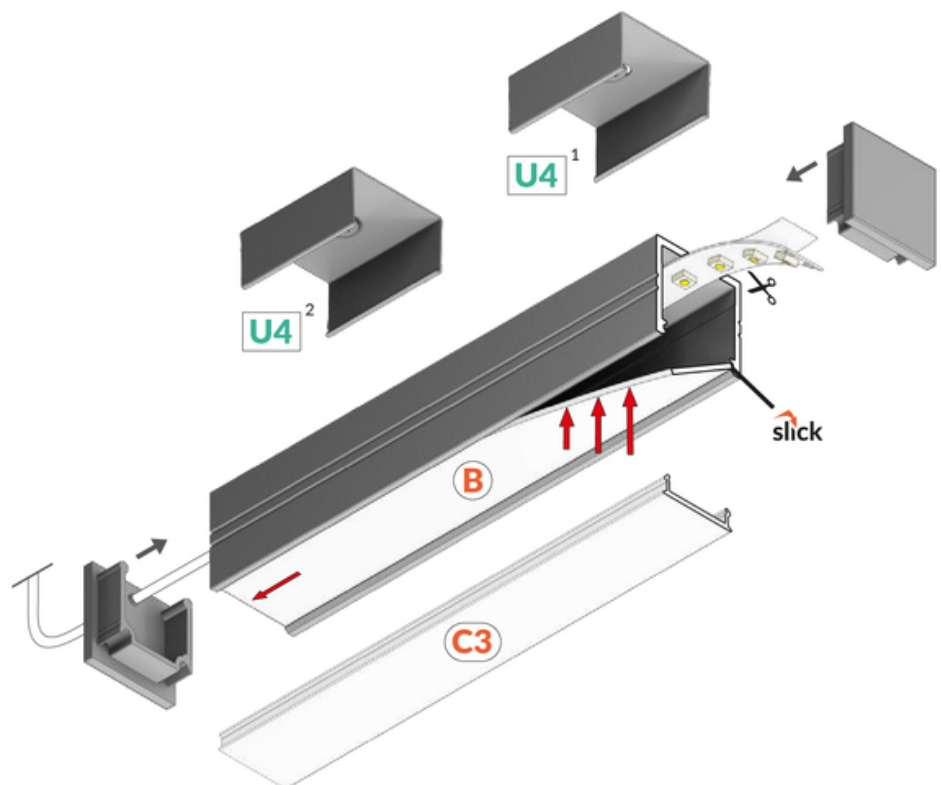
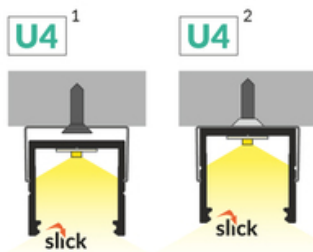
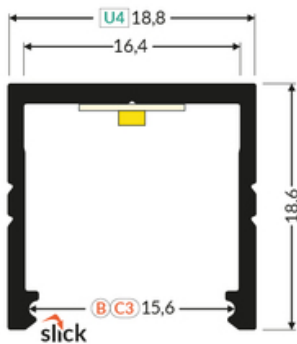

TOPMET LIGHT KŁOSOWICZ WIŚNIEWSKI sp. z o.o.

Ostrowska 354 | 61-312 Poznań | POLAND

tel.: +48 61 872 75 00

info@topmet.pl

pdf card generation date: 01.07.2026





Basic Informations

EAN: 5901597251712 Index: F1030021 Material: aluminium Color: black anodized Length [mm]: 3000 Weight [kg]: 0.621 Net weight [kg]: 0.008 Country of origin: PL	Measurement unit: qty Product packaging dimensions [mm]: 3000 x 18,8 x 18,6 Bulk packing [qty]: 10 Master packaging type: Bulk Product with gross packaging weight [kg]: 6.21
---	---

AVAILABLE COLORS

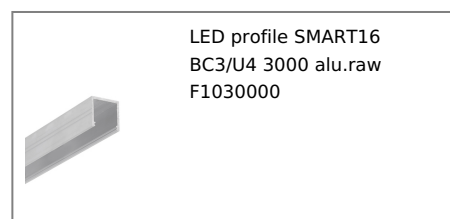
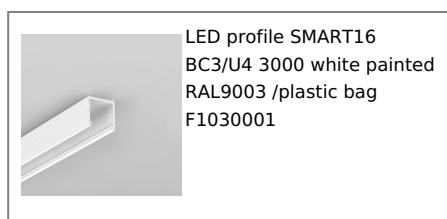
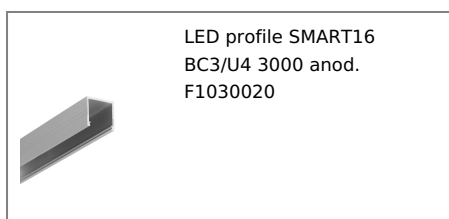

AVAILABLE VARIANTS

1000 mm, 2000 mm, 3000 mm, 4050 mm

Matching elements

DIFFUSERS

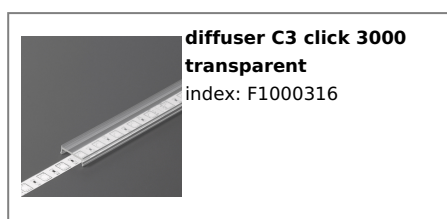
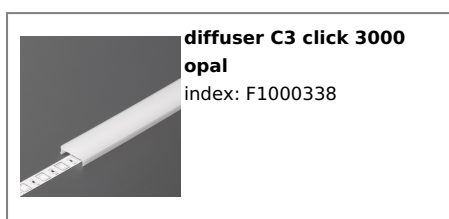

END CAPS



**end cap SMART16-BC3
black [20pcs]**
index: F1999902

MOUNTING PLATES



**mounting plate U4 cone
black [20pcs]**
index: F1980002

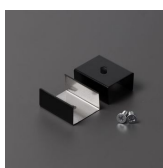

**mounting plate U4 black
[20pcs]**
index: F1970002