

LED PROFILE SMART10 AC2/Z 3000 ANOD.







Surface



Furniture

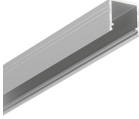

max 10 mm

	<ul style="list-style-type: none"> • continuous line of light (when using LED strip 120 P/m and opal diffuser) • Slick socket • miniature dimensions • universal application • the possibility of using waterproof LED strips 	 CE  EU industrial designs  Made in Poland	 <p>Buy product</p>
---	--	---	---

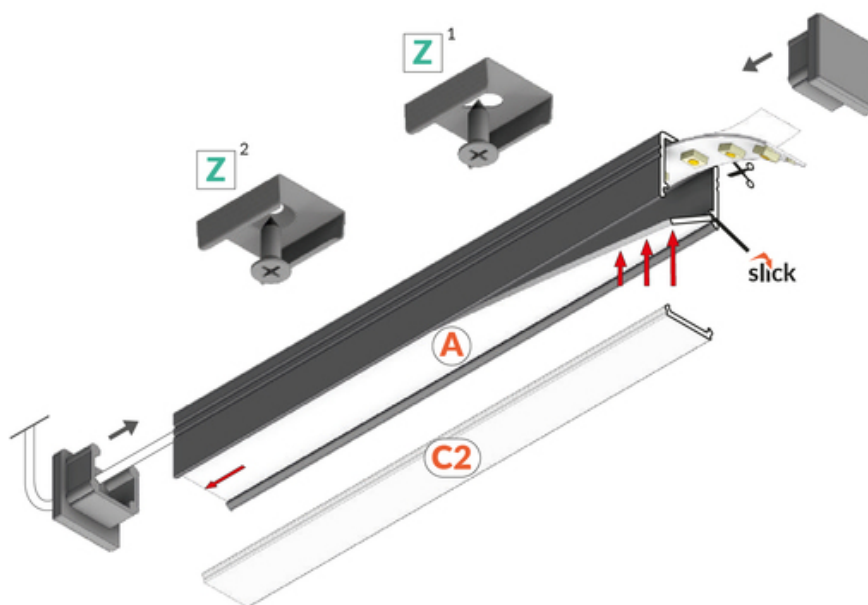
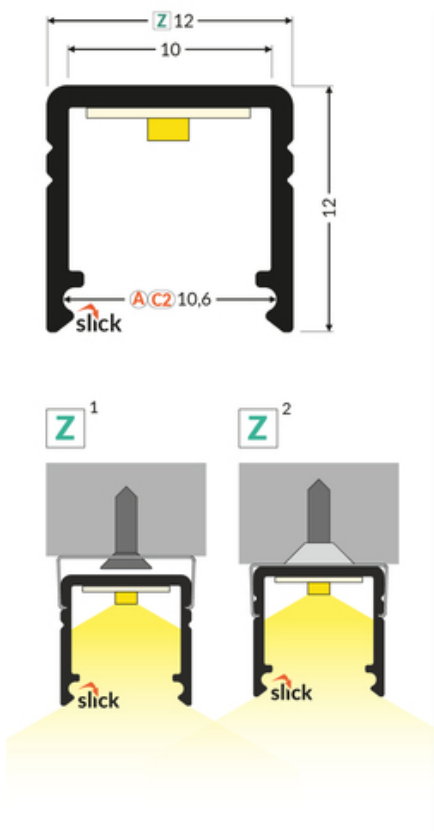

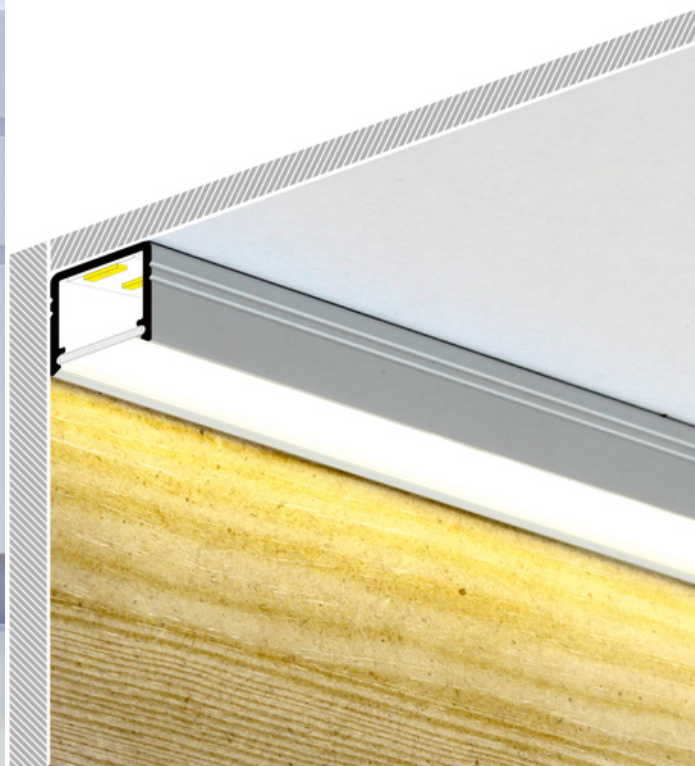



Basic Informations

<p>EAN: 5901597251521 Index: C2030020 Material: aluminium Color: anodized Length [mm]: 3000 Weight [kg]: 0.273 Net weight [kg]: 0.024 Country of origin: PL</p>	<p>Measurement unit: qty Product packaging dimensions [mm]: 3000 x 12 x 12 Bulk packing [qty]: 40 Master packaging type: Bulk Product with gross packaging weight [kg]: 10.92</p>
---	---

AVAILABLE COLORS



 <p>LED profile SMART10 AC2/Z 3000 white painted RAL9003 /plastic bag C2030001</p>	 <p>LED profile SMART10 AC2/Z 3000 black anod. /plastic bag C2030021</p>	 <p>LED profile SMART10 AC2/Z 3000 raw alu. C2030000</p>
---	---	---

AVAILABLE VARIANTS

1000 mm, 2000 mm, 3000 mm, 4050 mm

Matching elements

DIFFUSERS

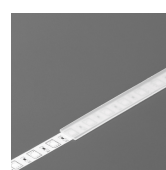
 <p>diffuser C2 click 3000 opal index: 89000338</p>	 <p>diffuser C2 click 3000 transparent index: 89000316</p>	 <p>diffuser A slide 3000 frosted index: 89000839</p>
--	---	--

MOUNTINGS



**mounting plate Z inox
[500pcs]**
index: 89270019W

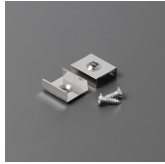

**mounting plate Z cone
inox [500pcs]**
index: 89980019W



**mounting plate Z inox
[20pcs]**
index: 89270019



**mounting plate Z cone
inox [20pcs]**
index: 89980019

END CAPS



**end cap SMART10 grey
[20pcs]**
index: C2940022



**end cap SMART10 silver
[20pcs]**
index: C2940040



**end cap SMART10 with
hole grey [20pcs]**
index: C2960022



**end cap SMART10 with
hole silver [20pcs]**
index: C2960040



**end cap SMART10 with
hole grey [500pcs]**
index: C2960022W

CONNECTORS



**connector SMART10
90deg anod. /plastic bag**
index: C2910020