

LED PROFILE PHIL53 C10 4050 WHITE PAINTED RAL9003

/PLASTIC BAG



Surface



Lighting



- profile for creating LED luminaires
- perfect as main lighting
- various installation options
- larger sizes
- 3 types of covers available with different light distributions
- enables hiding the power supply inside the profile



EU industrial designs



CE



Made in Poland



Buy product

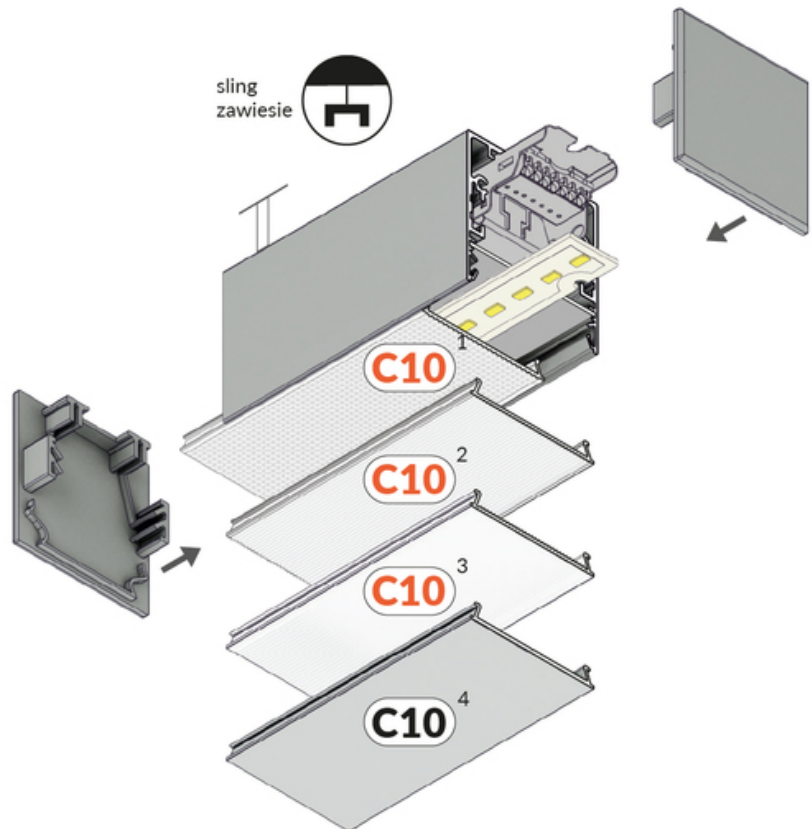
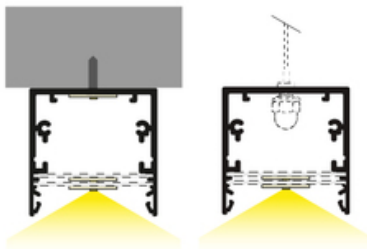
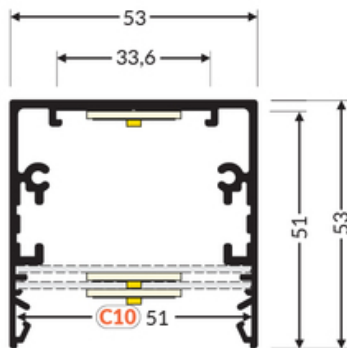

TOPMET LIGHT KŁOSOWICZ WIŚNIEWSKI sp. z o.o.

Ostrowska 354 | 61-312 Poznań | POLAND

tel.: +48 61 872 75 00

info@topmet.pl

pdf card generation date: 30.06.2026





Basic Informations

<p>EAN: 5901597254393 Index: 63730001 Material: aluminium Color: white painted Length [mm]: 4050 Weight [kg]: 4.039 Net weight [kg]: 0.018 Country of origin: PL</p>	<p>Measurement unit: qty Product packaging dimensions [mm]: 4050 x 53 x 53 Bulk packing [qty]: 4 Master packaging type: Bulk Product with gross packaging weight [kg]: 16.156</p>
--	---

AVAILABLE COLORS

 <p>LED profile PHIL53 C10 4050 anod. /plastic bag 63730020</p>	 <p>LED profile PHIL53 C10 4050 raw alu. 63730000</p>	 <p>LED profile PHIL53 C10 4050 black painted RAL9005 /plastic bag 63730002</p>
--	--	--

AVAILABLE VARIANTS

1000 mm, 2000 mm, 3000 mm, 4050 mm

Matching elements

DIFFUSERS

 <p>diffuser C10 click 4100 wide index: 63780000</p>	 <p>diffuser C10 click 4100 narrow index: 63800000</p>	 <p>diffuser C10 click 4100 opal index: 63700038</p>
 <p>diffuser C10 click 4100 pro index: P2001216</p>	 <p>diffuser C10 click 4100 basic index: P2001638</p>	

END CAPS

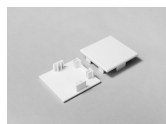

end cap PHIL53 white
/plastic bag [2pcs]
index: 63640001

OTHER



LED mounting 50 4050
index: 25180000

COMPLEMENTARY PROFILE

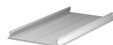

cover C10 4050 anod.
index: 63750020

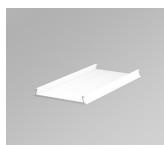

cover C10 4050 white
painted RAL9003 /plastic
bag
index: 63750001



cover C10 4050 black
painted RAL9005 /plastic
bag
index: 63750002

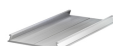

cover C10 4050 raw alu.
index: 63750000